

# Bi-Spectral Bullet Network Camera User Manual







# Precautions

## Precautions

Fully understand this document before using this device, and strictly observe rules in this document when using this device. If you install this device in public places, provide the tip "You have entered the area of electronic surveillance" in an eye-catching place. Failure to correctly use electrical products may cause fire and severe injuries. To prevent accidents, carefully read the following context:

## Symbols

This document may contain the following symbols whose meanings are described accordingly.

Symbol	Description
 <b>DANGER</b>	It alerts you to fatal dangers which, if not avoided, may cause deaths or severe injuries.
 <b>WARNING</b>	It alerts you to moderate dangers which, if not avoided, may cause minor or moderate injuries.
 <b>CAUTION</b>	It alerts you to risks. Neglect of these risks may cause device damage, data loss, device performance deterioration, or unpredictable results.
 <b>TIP</b>	It provides a tip that may help you resolve problems or save time.
 <b>NOTE</b>	It provides additional information.

### **DANGER**

To prevent electric shocks or other dangers, keep power plugs dry and clean.

### **WARNING**

Strictly observe installation requirements when installing the device. The manufacturer shall not be held responsible for device damage caused by users' non-conformance to these requirements.

Strictly conform to local electrical safety standards and use power adapters which are marked with the LPS standard when installing and using this device. Otherwise, this device may be damaged.

Use accessories delivered with this device. The voltage must meet input voltage requirements for this device.

If this device is installed in places with unsteady voltage, ground the device to discharge high energy such as electrical surges in order to prevent the power supply from burning out.

When this device is in use, ensure that no water or any liquid flows into the device. If water or liquid unexpectedly flows into the device, immediately power off the device and disconnect all cables (such as power cables and network cables) from this device.

Do not place the thermal imaging camera and unpackaged products at a radiation source with a high intensity regardless of whether the device is in the normal power-on state, for example, the sun, laser, and electric arc welder, and place the thermal imaging camera and unpackaged products against objects with a high heat source, for example, the sun. Otherwise, the accuracy of the thermal imaging camera will be affected. In addition, the detector in the thermal imaging camera may be permanently damaged.

If this device is installed in places where thunder and lightning frequently occur, ground the device nearby to discharge high energy such as thunder strikes in order to prevent device damage.



## CAUTION

Unless otherwise specified in the user manual, do not use the thermal imaging camera in an environment with the temperature lower than  $-20^{\circ}\text{C}$  ( $-4^{\circ}\text{F}$ ) or higher than  $60^{\circ}\text{C}$  ( $+140^{\circ}\text{F}$ ). Otherwise, the images displayed by the thermal imaging camera are abnormal and the device may be damaged if working beyond the temperature range for a long period.

During the outdoor installation, prevent the morning or evening sunlight incidence to the lens of the thermal imaging camera. The sun shade must be installed and adjusted according to the angle of the sunlight illumination.

Avoid heavy loads, intensive shakes, and soaking to prevent damages during transportation and storage. The warranty does not cover any device damage that is caused during secondary packaging and transportation after the original packaging is taken apart.

This device is a static sensitivity device. Improper static may damage the thermal imaging camera. ESD protection measures and reliable grounding must be well prepared for device installation and uninstallation.

Protect this device from fall-down and intensive strikes, keep the device away from magnetic field interference, and do not install the device in places with shaking surfaces or under shocks.

Use a soft and dry cloth to clean the device body. In case that the dirt is hard to remove, use a dry cloth dipped in a small amount of mild detergent and gently wipe the device, and then dry it again. Pay special attention to the front window of the thermal imaging camera because this is precision optics. If the front window has water spots, use a clean and soft cloth moistened with water to wipe it. If the front

window needs further cleaning, use a soft cloth dampened with isopropyl alcohol or detergent. Improper cleaning can cause damage to the device.

The lens window of the thermal imaging camera is designed to be applicable to an outdoor environment. The window is coated with durable coating material, but may require frequent cleaning. When you found lens image degradation or excessive accumulation of pollutants, you should clear up the window in a timely manner. Exercise caution when you use this device in severe sandstorm (such as deserts) or corrosive environments (such as offshore). Improper use may cause surface coating off.

Do not jam the ventilation opening. Follow the installation instructions provided in this document when installing the device.

Keep the device away from heat sources such as radiators, electric heaters, or other heat equipment.

Keep the device away from moist, dusty, extremely hot or cold places, or places with strong electric radiation.

If the device is installed outdoors, take insect- and moisture-proof measures to avoid circuit board corrosion that can affect monitoring.

Remove the power plug if the device is idle for a long time.

Before unpacking, check whether the fragile sticker is damaged. If the fragile sticker is damaged, contact customer services or sales personnel. The manufacturer shall not be held responsible for any artificial damage of the fragile sticker.

## Special Announcement

All complete products sold by the manufacturer are delivered along with nameplates, operation instructions, and accessories after strict inspection. The manufacturer shall not be held responsible for counterfeit products.

This manual may contain misprints, technology information that is not accurate enough, or product function and operation description that is slightly inconsistent with the actual product. The manufacturer will update this manual according to product function enhancement or changes and regularly update the software and hardware described in this manual. Update information will be added to new versions of this manual without prior notice.

This manual is only for reference and does not ensure that the information is totally consistent with the actual product. For consistency, see the actual product.

# Contents

<b>Precautions</b> .....	<b>I</b>
<b>Contents</b> .....	<b>IV</b>
<b>1 Product Overview</b> .....	<b>7</b>
1.1 About Product.....	7
1.2 Device Dimension .....	7
1.3 Installation.....	10
1.3.1 Installation Mode .....	10
1.3.2 Installing Bracket Without Junction Box.....	10
1.3.3 Installing Bracket With Junction Box.....	11
1.4 Cable Connection .....	13
1.5 Packing List.....	14
<b>2 Device Login</b> .....	<b>15</b>
2.1 Login and Logout .....	15
2.2 Change Password .....	18
2.3 Homepage Layout .....	19
2.4 Playback.....	22
2.5 IVS Setting.....	25
<b>3 Quick Start Settings</b> .....	<b>27</b>
3.1 Local Network.....	27
3.2 Video .....	29
3.3 Optical Channel Display .....	33
3.3.1 Access the Display Settings.....	33
3.3.2 Mode .....	34
3.3.3 Image Setting .....	35
3.3.4 Scene Mode.....	36
3.3.5 Exposure .....	37
3.3.6 White Balance Setting.....	39
3.3.7 Day/Night.....	41
3.3.8 Noise Reduction.....	44
3.3.9 Image Enhancement .....	45
3.4 Thermal Channel Display.....	47
3.4.1 Mode .....	47
3.4.2 Image .....	47

---

3.4.3 Scene.....	48
3.4.4 Set Pseudocolor.....	49
3.4.5 FFC Control.....	51
3.4.6 Noise Reduction.....	53
3.5 OSD.....	54
3.6 Date and Time.....	56
<b>4 Configuring Thermal.....</b>	<b>59</b>
4.1 Settings.....	59
4.1.1 Temperature Parameters.....	59
4.1.2 Ambient Temperature.....	65
4.1.3 Privacy Zone Masking.....	66
4.1.4 Thermal Mapping.....	67
4.1.5 Defect Pixel Correction.....	68
4.1.6 Version Information.....	70
4.2 Temperature Alarm.....	70
4.3 Schedule Linkage.....	76
4.4 Led Control Param.....	78
<b>5 IVS Settings.....</b>	<b>80</b>
5.1 AI Multi-object.....	80
5.2 Intelligent Analysis.....	81
5.2.1 Intrusion.....	81
5.2.2 Smart Motion.....	84
5.2.3 Single Line Crossing.....	85
5.2.4 Double Line Crossing.....	87
5.2.5 Multi-Loitering.....	89
5.2.6 Wrong -Way.....	89
5.2.7 Enter Area.....	90
5.2.8 Leave Area.....	91
5.3 Environmental Safety Analysis.....	91
5.3.1 Smoking Detection.....	91
5.3.2 Smoke and Flame Detection.....	92
5.3.3 Fire Spot Detection.....	93
5.4 People Counting.....	95
5.4.1 Set.....	95
5.4.2 Report.....	97
<b>A Troubleshooting.....</b>	<b>99</b>
<b>B Common Emission Rate.....</b>	<b>101</b>

# 1 Product Overview

---

## 1.1 About Product

The Bi-spectrum network camera is integrated with the thermal imaging and temperature measuring, visible fusion, core image intelligent analysis, etc.

Unique double registration mechanism, visible light and thermal imaging is reflecting the same scene.

The Bi-spectrum network camera is high precision, built-in automatic temperature correction, completely eliminate the temperature drift, it can work stable and reliable for long time.

Intelligent temperature and visible light image channel display details information to easily monitor and discriminate.

Smart over temperature alarm and location, sound and light alarm, track rapidly when temperature was abnormal.

It can be widely used in important fields such as airports, stations, urban roads, traffic surveys, corporate security, warehouse monitoring, and residential security.

## 1.2 Device Dimension

Figure 1-1 shows the dimensions of device.

Figure 1-1 Dimensions (unit: mm)

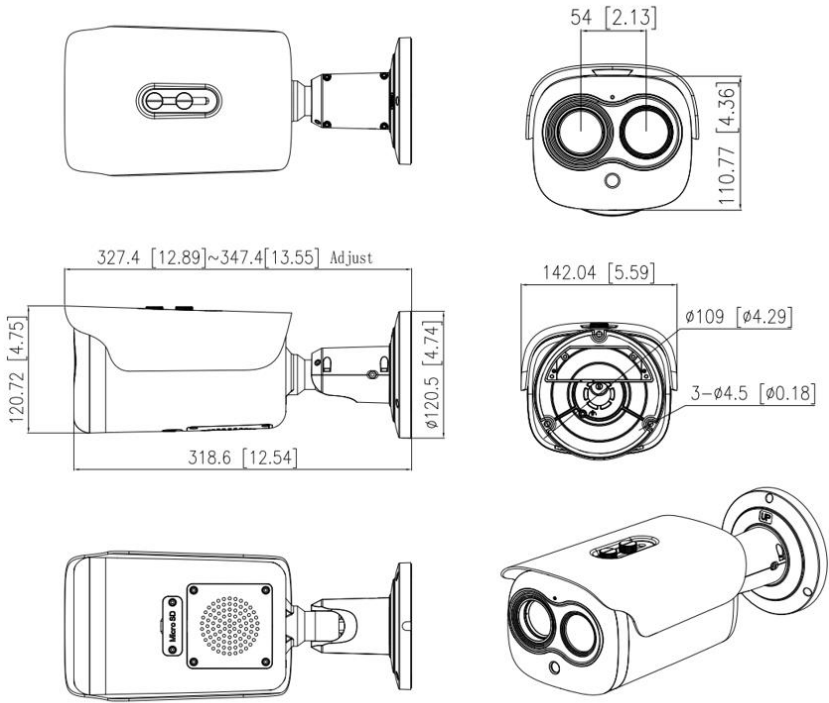

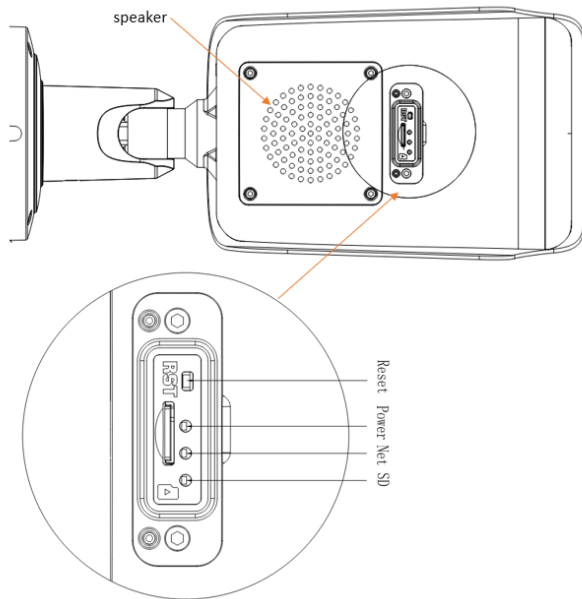
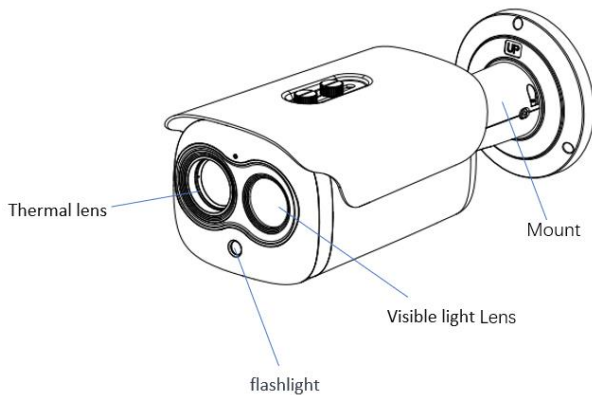

Reset : Reset button, long press for 5s to restore to factory settings.

Power : If the power is normal, the red light is on.

NET: Network indicator, if the data is transiting, the green light is flash.

SD: SD card indicator, if the micro SD card is plugged, the blue light is on.

## 1.3 Installation

### 1.3.1 Installation Mode

The thermal imaging bullet camera can be installed on the ceiling or the wall. You can select the appropriate installation according to your requirements. If the camera needs to be installed on the cement wall, you need to install the expansion screws (the mounting holes of the screws must be consistent with that of the support), and then install the support.



#### NOTE

The wall where the bracket is mounted must be able to withstand at least three times of the total weight of the bracket and the camera.

The different brackets have different installation methods, please choose the correspond method according to the purchased product.

### 1.3.2 Installing Bracket Without Junction Box

Step 1 Take out the installation location label from the package, stick it on the ceiling or the wall.

Step 2 According to the location hole positions shown in the installation location label, punch three location holes on the ceiling or the wall.

Step 3 Drive the plastic anchors into the holes, as shown in Figure 1-2.

Figure 1-2 Installation location label

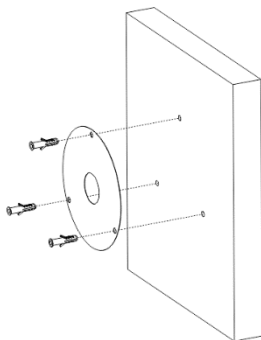

Step 4 Align the holes in bracket with the plastic anchors in ceiling or wall, fix the bracket with self-tapping screws, as shown in Figure 1-3.

Figure 1-3 Fixing camera

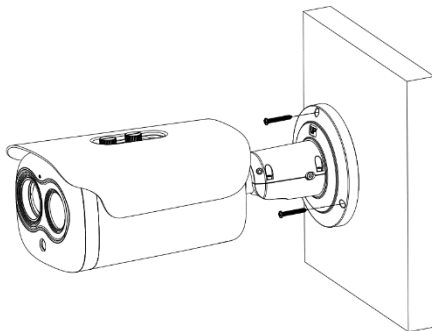

Step 5 Connect the multi connector cable. Loosen the screw 1 and screw 2, adjust the surveillance angle

Step 6 After adjusting angle, fix screw 2 and screw 1 in turn to finish installation, as shown in Figure 1-4.

Figure 1-4 Adjust the surveillance angle

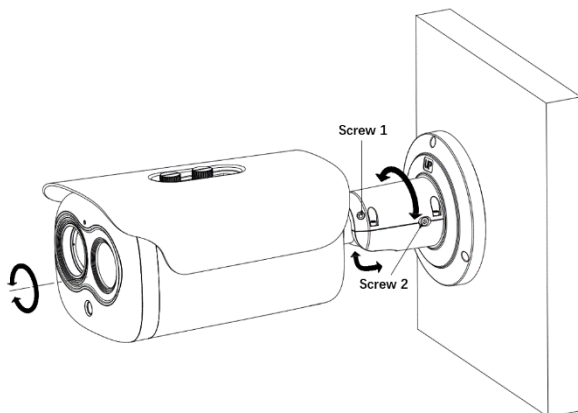

----End

### 1.3.3 Installing Bracket With Junction Box

Step 1 Take out the installation location label from the package, stick it on the ceiling or the wall. According to the location hole positions shown in the installation location label, punch four location holes on the ceiling or the wall.

Step 2 Drive the plastic anchors into the holes, fix the junction box by self-tapping screws.

Step 3 Wiring of junction box. Align the holes in bracket with the box and fix the camera to the box with self-tapping screws, as shown in Figure 1-5.

Figure 1-5 Fix the camera to junction box

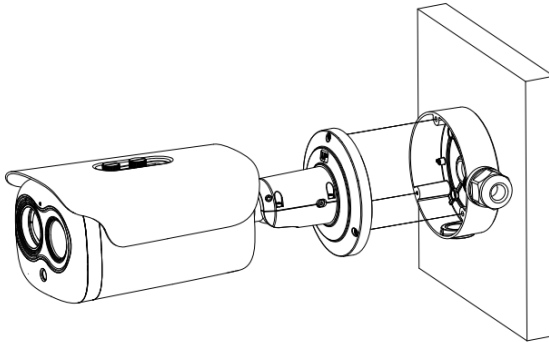

Step 4 Connect the multi connector cable. Loosen screw 1 and screw 2, adjust the surveillance angle, as shown in Figure 1-6.

Figure 1-6 Adjust the surveillance angle

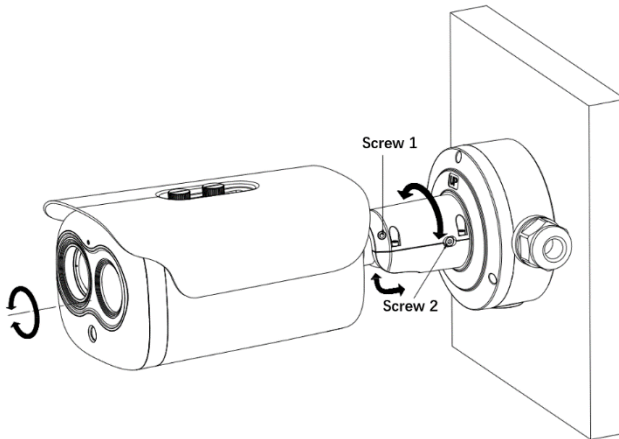

Step 5 After adjusting angle, fix screw 2 and screw 1 in turn to finish installation.

**NOTE**

There are three pipe thread interface in the junction box, one of which needs to be used with Grand head, so our company provides two plugs.

---End

## 1.4 Cable Connection

Figure 1-7 shows the ports of multi-pole combined cables. Table 1-1 describes the ports.

 **NOTE**

The different models may have different cables, please refer to actual product.

Figure 1-7 Multi-connector combination cables

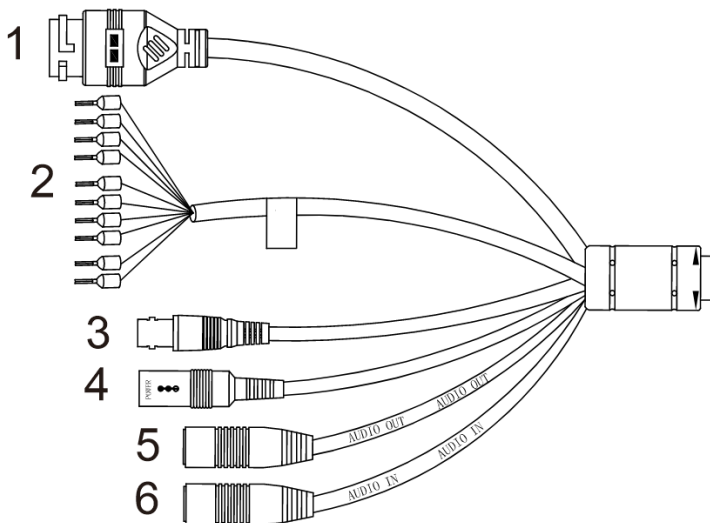

Table 1-1 Multi-connector combination cables

ID	Core of Cable	Functions
1	Network interface	Connect to the standard Ethernet cable. Support PoE power supply.
2	ALARM	Orange: alarm OUT COM 2 Yellow: alarm OUT 2 Grey: alarm IN COM 2 Purple : alarm IN 2 Brown: alarm OUT COM 1 Blue: alarm OUT 1 White: alarm IN COM 1 Green: alarm IN 1
	RS485	RS485 interface connects to the external pan & tilt. Pink & red is RS485+

		Black & white is RS485-
3	BNC	CVBS interface
4	DC12V/AC24V (2A)	Power interface, connects to the DC12V or AC24V (2A)
5	Audio Output	Connect to the external audio device such as the voice box.
6	Audio Input	Input the audio signal and receives the analog audio signals from the sound pick-up device.

## 1.5 Packing List

Open the package, check the appearance of product for no obvious damage, and confirm whether the items are consistent with the list.

Table 1-2 Packing list

Component	Quantity	Remark
Bi-spectrum network camera	1	
User manual	1	
Position sticker	1	
Ethernet port waterproof cover	1	
Self-tapping screw	3	Standard
Plastic anchor	3	
S5 / S2.5 Allen key	1/1	
Junction box	1	Optional
T15 wrench	1	
Terminal block	2	
Self-tapping screw	4	
Plastic anchor	4	

---

## 2 Device Login

---

### 2.1 Login and Logout

---



#### CAUTION

To access the web interface through Microsoft Edge, Chrome or Firefox browser; Otherwise some functions may be unavailable.

---

#### Login

- Step 1 Open Chrome browser, enter the IP address of the IP camera (default value: 192.168.0.121) in the address box, and click on the **Enter** button.
- Step 2 Create password when you login for the first time, then jump to the login interface

Figure 2-1 Create password



## Please Create Password

English ▾

User Name

New Password ?

Please Input New Password

Confirm

Create

Step 3 Enter the user name and password. The login page is displayed, as shown in Figure 2-2.

Figure 2-2 Login page

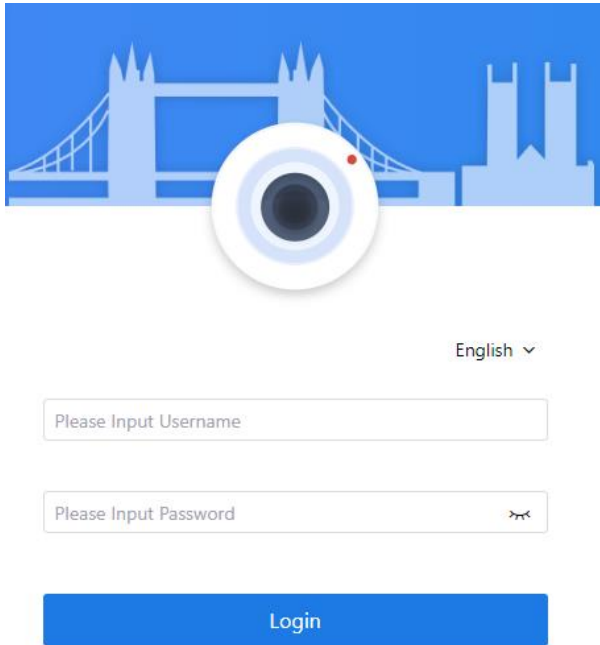
The login page features a blue header with a white silhouette of a suspension bridge and a camera lens icon. Below the header, there is a language selector set to 'English'. The main form consists of two input fields: 'Please Input Username' and 'Please Input Password'. A blue 'Login' button is positioned below the password field.

English ▾

Please Input Username

Please Input Password 

Login



**NOTE**

- The default username is admin. Users should create the password for the first time login.
- DHCP is on by default. Please use tool to search IP, the default IP address is 192.168.0.121.
- After modifying password, you need to wait at least three minutes then power off to make sure modify it successfully. Or login the Web again to test the new password.
- You can change the system display language on the login page.

Step 4 Click **Login** to enter the homepage.

---End

Sign out

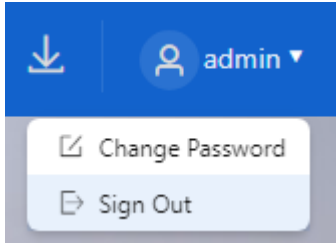

Click [sign out](#) in the upper right to return to login page.

## 2.2 Change Password

Description

Step 1 Click the username on the upper right, choose **Change Password** to enter the change password is as shown in Figure 2-3.

Or choose **Setting > System > Change Password**.

Figure 2-3 Change the default password page

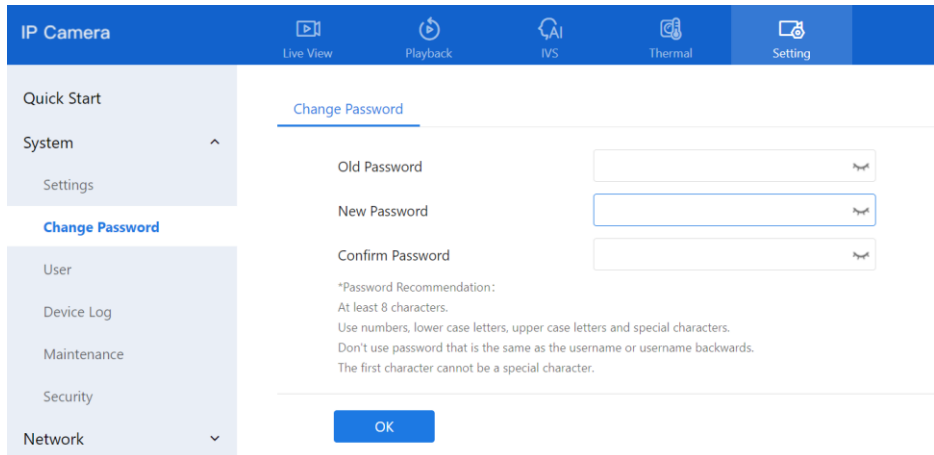

### NOTE

- At least 8 characters.
- Use numbers, lower case letters, upper case letters and special characters.
- Don't use password that is the same as the username or username backwards.
- The first character cannot be a special character.

Step 2 Input the old password, new password, and confirm password.

Step 3 Click **OK**.

If the message " Change your password success!" pops up, the password is successfully changed. If the password fails to be changed, there will be some tips for changing password. (For example, the new password length couldn't be less than eight.).

It is advised to restart the device three minutes later after modifying password.

Step 4 Click **OK**. The login page is displayed.

---End

## 2.3 Homepage Layout

On the homepage, you can view real-time videos, receive alarm and fault notifications, set parameters, change the password, and log out of the system. Figure 2-4 shows the homepage layout. Table 2-1 describes the elements on the homepage.

Figure 2-4 Homepage layout

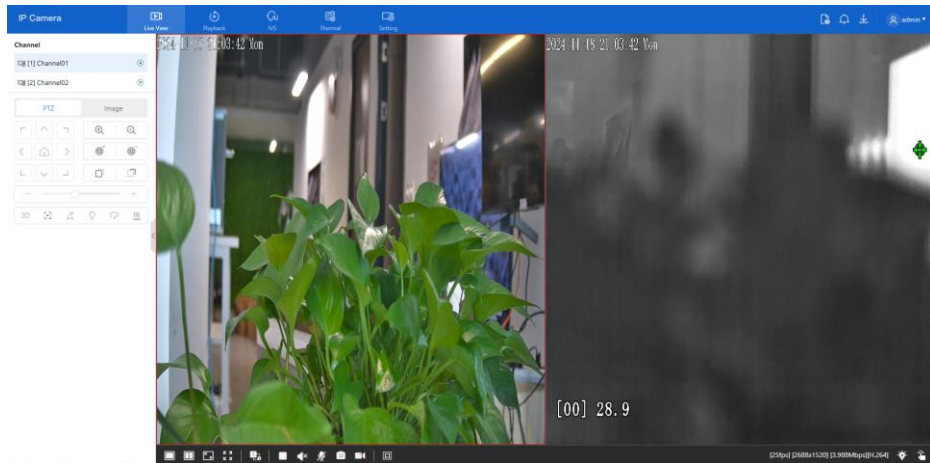





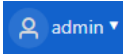
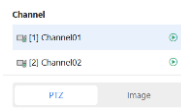

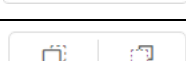
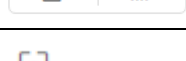
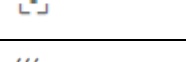











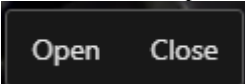

Table 2-1 Elements on the homepage

No.	Element	Description
1	Live View	Real-time videos are played in this page.

No.	Element	Description
2	Playback	You can query the playback videos in this area. NOTE Only when the micro SD card or NAS has videos can you query the playback videos.
3	IVS setting	Intelligent Video System, set the ai multi-target, intelligent analysis (intrusion, smart motion, single line crossing, double line crossing, multi-loitering, wrong-way, general parameters), people counting and so on
4	Setting	You can choose a menu to set device parameters, quick start, system, network, audio /video, image, event, and storage.
5		About the intercom function.
6		When the device accepts an alarm signal, the alarm icon will display  . You can click  to view the alarm information.
7		SD card video backup and download status.
8	 admin ▾	Current user, sign out or change password.
9		The status of playing real-time video. Channel 1 is optical channel, Channel 2 is thermal channel. Set the PTZ and image parameters.
10		Zoom +/ zoom -
11		Iris +/ iris -
12		Near focus /far focus
13		Auto focus
14		Heating, when the optical lens is fogging, click heating to defog

No.	Element	Description
15	Image	Set brightness, saturation, contrast and sharpness.
16		Play one channel's video / play two channels' video.
17		Window scale, switch the scale of play live video.
18		Full screen, click the icon to play live video at full screen.
19		Stream, click icon to switch stream. There are two modes stream.
20		Pause/Start. Close live video or play live video.
21		Audio. Open or close audio.
22		Two-way audio. Open or close intercom, the computer should be plugged in microphone in advance.
23		Click the icon to snapshot the video and save the images to the specified location.
24		Record the video and save the file to the specified location.
25		<div data-bbox="524 951 809 1086" style="background-color: #333; color: white; padding: 10px; margin-bottom: 10px;"> <p>Target Frame</p> <p>Intelligent marking</p> </div> <p>Target frame: when detect the target, it will show frame on target.</p> <p>Intelligent marking: the detection area frame of the intelligent analysis in IVS will be displayed in the live video interface.</p>
26		Frame rate / resolution / bit rate / video encode type.
27		<p>I/O output, control the I/O alarm output manually. Click  to open alarm or close the alarm.</p>

No.	Element	Description
28		Open or close the flashing light manually, for the special models.

Figure 2-5 About the intercom function



## 2.4 Playback

Click “Playback” at web interface. If users install SD card, and there are videos in SD card.

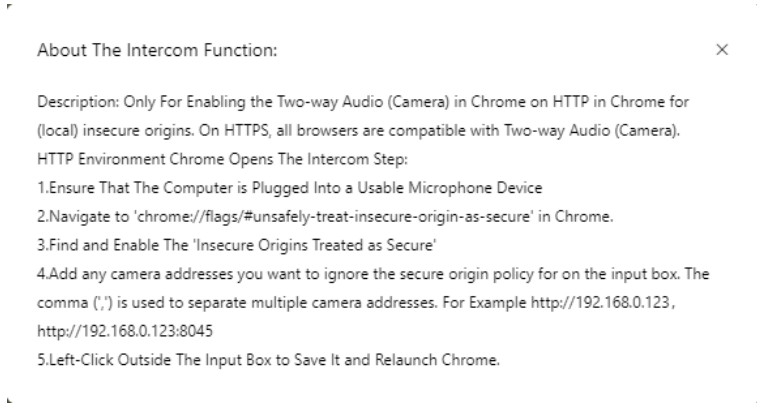









Click “Playback” and the playback video will show as in Figure 2-6.

Figure 2-6 Playback page



Table 2-2 Playback function

No.	Element	Description
1	Channel	The channel list of cameras
2	Calender	 the green point means it has recording video. Set the time to play recording.

3	 Schedule Record  All Types	<p>All Types</p> <p>I/O Alarm</p> <p>Motion Alarm</p> <p>Day/Night Switch Alarm</p> <p>Abnormal Audio Alarm</p> <p>Intrusion</p> <p>Smart Motion</p> <p>Single Line Crossing</p> <p>Double Line Crossing</p> <p>Multi-Loitering</p> <p>The green timeline represents scheduled recording and the red timeline is alarm recording. The types of alarm recording vary according to model performance.</p>
4		<p>One screen plays recording. Choose one day has recording, click  to play.</p>
5		<p>Two screens play recording. Choose the screen, choose the channel, select one day which has recording(the date shows green point) , click  to play.</p>
6		<p>Four screens play recording. Choose the screen, choose the channel, select one day which has recording(the date shows green point) , click  to play.</p>
7		<p>Window scale, switch the scale of play recording video.</p>
8		<p>Full screen, click the icon to play recording video at full screen.</p>
9		<p>Pause/Start. Close live video or play recording video.</p>





10		Audio. Open or close audio.
11		Click the icon to snapshot the video and save the images to the specified location.
12		Fast Forward, 1/16X, 1/8 X, 1/4 X, 1/2 X, 1 X, 2 X, 4 X, 8 X
13		<p>click the icon to start backup, drag the bar to download recording quickly, click the icon again to end up. The pop-up window of tip as shown in Figure 2-7, click the save to save the video. Click <b>Cancel</b> to abandon.</p>  <p>the backup list to show the detail information.</p>
14		Time axis, users can choose 1h, 6h, 12h, 24h.

Figure 2-7 Record backup tip

Tip

Begin Time

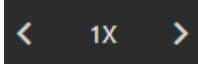
2024-11-19 00:00:01

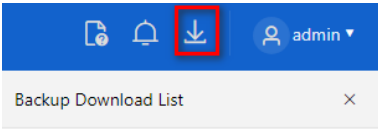
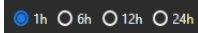
End Time

2024-11-19 00:01:57

Cancel

OK

## 2.5 IVS Setting

Click IVS to enter IVS setting page, users can set the deep learning, intelligent analysis, behavior analysis as shown in Figure 2-8. The detail settings will be introduced at the following chapters.

Figure 2-8 IVS setting page

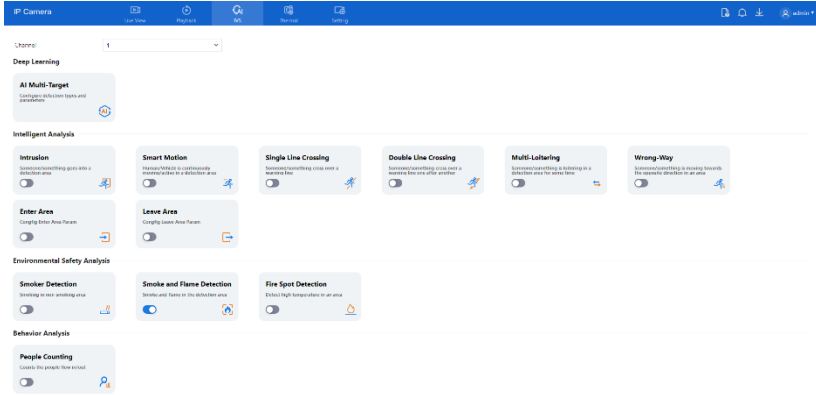

**NOTE**

The different models have different IVS functions, please refer to actual product.

---End

# 3 Quick Start Settings

## 3.1 Local Network

### Description

Local network parameters include:

- IP protocol
- IP address
- Subnet mask
- Default gateway
- Dynamic Host Configuration Protocol (DHCP)
- Preferred Domain Name System (DNS) server
- Alternate DNS server
- MTU

### Procedure

Step 1 Choose **Setting > Quick Start > Local Network**.

The **Local Network** page is displayed, as shown in Figure 3-1.

Figure 3-1 Local network page

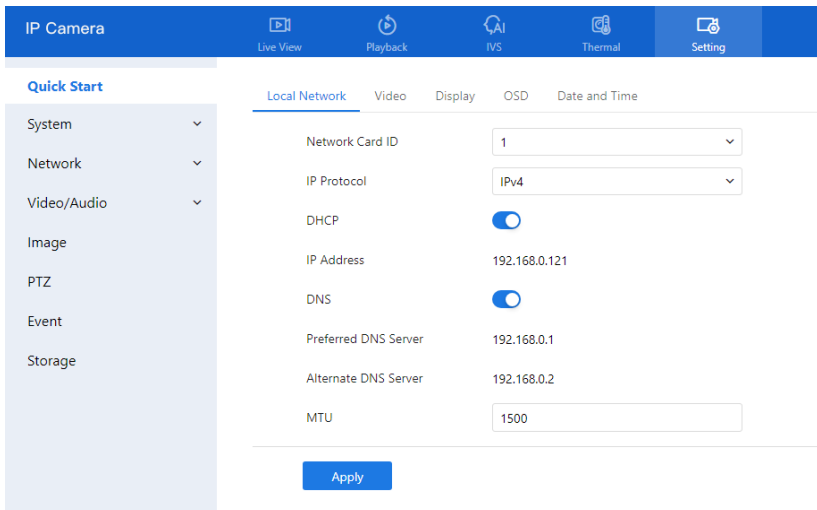

Step 2 Set the parameters according to Table 3-1.

Table 3-1 Local network parameters

Parameter	Description	Setting
Network Card ID	--	[Default value] 1
IP Protocol	IPv4 is the IP protocol that uses an address length of 32 bits. IPv6 is the IP protocol that uses an address length of 64 bits.	[Setting method] Select a value from the drop-down list box. [Default value] IPv4
DHCP	Enable DHCP, and the device will automatically obtain the IP address from the DHCP server.	[Setting method] Click the button on to enable <b>DHCP</b> . NOTE To query the current IP address of the device, you must query it on the platform based on the device name.
IP Address	Device IP address that can be set as required.	[Setting method] Enter a value manually. [Default value] 192.168.0.120
Subnet Mask	DHCP is off. Subnet mask of the network adapter.	[Setting method] Enter a value manually. [Default value] 255.255.255.0
Default Gateway	DHCP is off. This parameter must be set if the client accesses the device through a gateway.	[Setting method] Enter a value manually. [Default value] 192.168.0.1
Preferred DNS Server	DNS is on. IP address of a DNS server.	[Setting method] Enter a value manually. [Default value] 192.168.0.1
Alternate DNS Server	DNS is on. IP address of a domain server. If the preferred DNS server is faulty, the device uses the alternate DNS server to resolve domain names.	[Setting method] Enter a value manually. [Default value] 192.168.0.2

Parameter	Description	Setting
MTU	Set the maximum value of network transmission data packets.	[Setting method] Enter a value manually.  NOTE The MTU value is range from 1280 to 1500, the default value is 1500, Please do not change it arbitrarily.

Step 3 Click **Apply**.

If the message "Apply success!" is displayed, and the system will save the settings. The message "Set network parameter success, please login system again" is displayed. Use the new IP address to login to the web management system.

If the message "Parameter is Invalid " is displayed, please set the parameters correctly.

----End

## 3.2 Video

### Procedure

Step 1 Choose **Setting > Quick Start > Video**.

The **Video** page is displayed as shown in Figure 3-2.

Figure 3-2 Video setting page

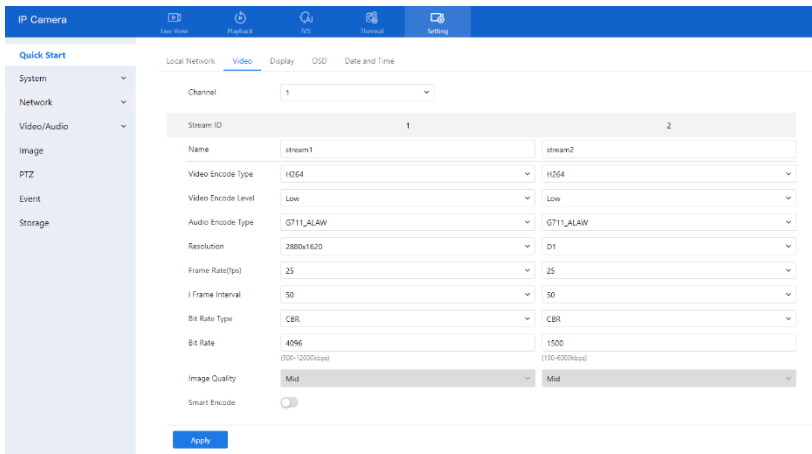

Step 2 Set the parameters according to Table 3-2.

Table 3-2 Parameters of stream configuration

Parameter	Description	Setting
Channel	Channel 1 is optical channel, channel 2 is thermal channel, which is applied to all settings.	[Setting method] Select a value from the drop-down list box
Stream ID	The device supports two streams. Streams 1 and 2 adopt H.264 code. Stream 1 stands for the best stream performance the device supports. Stream 2 usually offers comparatively low-resolution options	[Setting method] Select a value from the drop-down list box.
Name	Stream name. NOTE The stream name consists of character, number, character and underline.	[Setting method] Enter a value manually. The value cannot exceed 32 bytes. [Default value] Stream 1

Parameter	Description	Setting
Video Encode Type	<p>The video encode determines the image quality and network bandwidth required by a video. Currently, the following encode standards are supported:</p> <p style="text-align: center;"><b>MJPEG</b></p> <p>MJPEG is a standard intra-frame compression encode. The compressed image quality is good. No mosaic is displayed on motion images. MJPEG does not support proportional compression and requires large storage space. Recording and network transmission occupy large hard disk space and bandwidth. MJPEG is not applicable to continuous recording for a long period of time or network transmission of videos. It can be used to send alarm images.</p> <p style="text-align: center;"><b>H.264</b></p> <p>H.264 consists of H.264 low Profile, H.264 Main Profile and H.264 High profile. The performance of H.264 High Profile is higher than that of H.264 Main Profile, and the performance of H.264 Main Profile is higher than that of H.264 Base Profile. If a hardware decoding device is used, select the appropriate encode based on the decoding performance of the device.</p> <p>H.264 High Profile has the highest requirements on the hardware performance, and H.264 Base Profile has the lowest requirements for the hardware performance.</p> <p style="text-align: center;"><b>H.265</b></p> <p>H.265 is the advanced video encoding standard. It's the improvement standard from H.264. H.265 improves the streams, encoding quality and algorithm complexity to make configuration optimization.</p>	<p>[Setting method] Select a value from the drop-down list box.</p> <p>[Default value] H.264 High Profile</p> <p>NOTE</p> <p>The H.264 High Profile encode means high requirements on the hardware. If the hard-decoding capability is low, use H.264 Main Profile or H.264 Base Profile.</p> <p>When users choose the MJPEG for Stream 1, some functions will be error, such as the videos of FTP upload may not be play correctly.</p>
Audio Encode Type	<p>The following audio encode standards are supported:</p> <p style="padding-left: 40px;">G711_ULAW: mainly used in North America and Japan.</p> <p style="padding-left: 40px;">G711_ALAW: mainly used in Europe and other areas.</p> <p style="padding-left: 40px;">RAW_PCM: encode of the original audio data. This encode is often used for platform data.</p>	<p>[Setting method] Select a value from the drop-down list box.</p>
Resolution	<p>A higher resolution means better image quality.</p>	<p>[Setting method] Select a value from the drop-down list</p>

Parameter	Description	Setting
	NOTE IP cameras support different resolutions based on the model.	box.
Frame Rate(fps)	Frame rate is the number of images, screenshots, or frames that a camera can take per second. The frames per second determine the smoothness of a video. A video whose frame rate is higher than 22.5 f/s is considered as smooth by human eyes. Frame rates for different frequencies are as follows: 50 Hz: 1–25 f/s 60 Hz: 1–30 f/s NOTE The frequency is set on the <b>Device Configuration &gt; Camera</b> page. The biggest MJPEG coding format frame rate is 12 frames per second.	[Setting method] Select a value from the drop-down list
I Frame Interval(f)	I frame do not require other frames to decode. A smaller I frame interval means better video quality but higher bandwidth.	[Setting method] Select a value from the drop-down list
Bit Rate Type	The bit rate is the number of bits transmitted per unit of time. The following bit rate types are supported: Constant bit rate (CBR) The compression speed is fast; however, improper bit rate may cause vague motion images. Variable bit rate (VBR) The bit rate changes according to the image complexity. The encoding efficiency is high and the definition of motion images can be ensured.	[Setting method] Select a value from the drop-down list box.
Bit Rate Range	Indicates the maximal value of the bit rate. the different models may have different ranges, please refer to actual product.	[Setting method] Enter a value manually.
Image Quality	The video quality the camera output.	[Setting method] Select a value from the drop-down list box.
Smart Encode	Smart Encode. Smart encode includes H.264 & H.265.	[Setting method] Click the button on to enable <b>Smart Encode</b> .

Parameter	Description	Setting
	The storage space will be reduced fifty percent when smart encode is enabled. Only main stream supports smart encode.	

Step 3 Click **Apply**.

If the message "Apply success!" is displayed, and the system will save the settings.

If a message "Please enter the appropriate range" is displayed, enter a new value at the range.

----End

## 3.3 Optical Channel Display

### 3.3.1 Access the Display Settings

Operation Procedure:

Step 1 Choose **Setting > Quick Start > Display**, the channel chosen 1.

Figure 3-3 Display settings of optical-light channel page

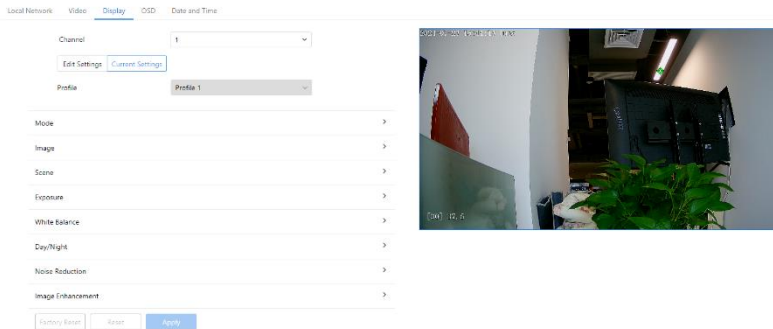
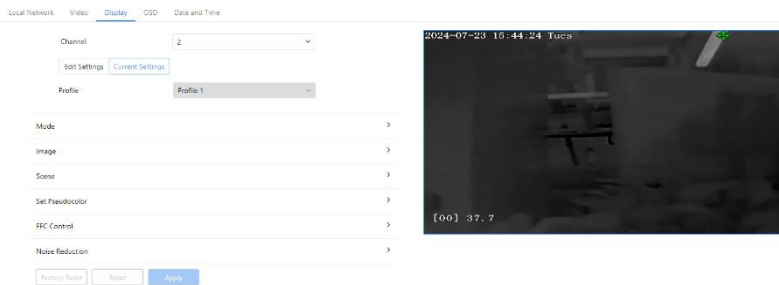

Figure 3-4 Display settings of thermal channel page



Step 2 Choose **Edit Settings** on Mode item to set the parameters. You can set four profiles.

#### NOTE

- All image settings can be modified at edit mode.
- Factory Reset: All parameters will be restored to the factory settings.
- Reset: the settings will be recovered to the last settings.

----End

## 3.3.2 Mode

Operation procedure:

Step 1 Choose **Setting > Quick Start > Display > Mode** tag on display interface, the Mode page is displayed, as shown in Figure 3-5.

Figure 3-5 Mode page

Mode

Switch Mode: None

Start Time: 00 : 00

End Time: 24 : 00

Step 2 Choose Switch Mode, there are three modes to be chosen, none, time mode, D/N linkage mode.

Time mode: It will switch to other profile at the set time. There are four profiles, you should set in advance.

D/N linkage mode: It will switch to day or night mode at the set time.

None: it will carry out the current profile.

Step 3 Set the start time and end time.

Step 4 Click **Apply** to save the setting.

----End

### 3.3.3 Image Setting

Step 1 Choose **Setting > Quick Start > Display > Image** tag on display interface, Figure 3-6 shows the image setting interface.

Figure 3-6 Image setting page

Image

Brightness: 50

Saturation: 50

Contrast: 50

Sharpness: 50

Step 2 Set the parameters according to Table 3-3.

Table 3-3 Parameters of image settings parameters

Parameter	Description	Configuration Method
<b>Brightness</b>	It indicates the total brightness of an image. As the value increases, the image becomes brighter.	[Setting method] Drag the slider. [Default value] <b>50</b>
<b>Saturation</b>	It indicates the color saturation of an image. As the value increases, the image becomes more colorful.	[Setting method] Drag the slider. [Default value] <b>50</b>
<b>Sharpness</b>	It indicates the clearness of an image. As the value increases, the image becomes more clearer.	[Setting method] Drag the slider. [Default value] <b>50</b>
<b>Contrast</b>	It indicates the contrast between the bright part and the dark part of an image. As the value increases, the contrast increases.	[Setting method] Drag the slider. [Default value] <b>50</b>

Step 3 Click **Apply** to save the setting.

----End

### 3.3.4 Scene Mode

Step 1 Choose **Setting > Quick Start > Display > Scene** tag on display interface, Figure 3-7 shows the **Scene** mode interface.

Figure 3-7 Scene mode page

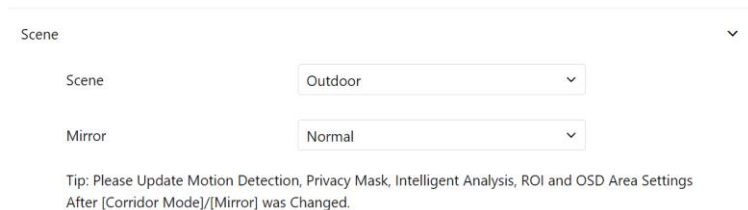

Step 2 Set the parameters according to Table 3-4.

Table 3-4 Parameters of FFC

Parameter	Description	Configuration Method
<b>Scene</b>	It indicates the working mode of camera. Outdoor: It applies to outdoor scenarios. Indoor: It applies to indoor scenarios.	[Configuration method] Select from the drop-down list [Default value] <b>Outdoor</b>
<b>Mirror</b>	It is used to select the pixel location of an image. Normal: The image does not flip. Horizontal: The image flips to the left and right. Vertical: The image flips up and down. Horizontal and vertical: The image rotates at 180 degrees.	[Setting method] Select a value from the drop-down list. [Default value] <b>Normal</b>

Step 3 Click **Apply** to save the setting.

---End

### 3.3.5 Exposure

Step 1 Choose **Setting > Quick Start > Display > Exposure** tag on display interface, Figure 3-8 shows the **Exposure** interface.

Figure 3-8 Exposure interface for IP camera

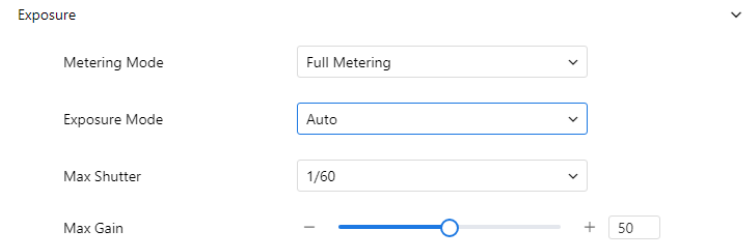

Step 2 Set the parameters according to Table 3-5.

Table 3-5 Parameters of exposure

Parameter	Meaning	Configuration Method
<b>Metering Mode</b>	<p>It is used to select the metering area.</p> <p><b>Fulling Metering:</b> During metering, all areas of an image have equal weight, that is, all areas are involved in the metering.</p> <p><b>Spot Metering:</b> During metering, the central spot of an image has the highest weight.</p> <p><b>Partial Metering:</b> During metering, the middle area (1/2 of the total area) of an image has the highest weight, and other areas have the lowest weight.</p>	<p>[Setting method] Select a value from the drop-down list. [Default value] <b>Whole</b></p>
<b>Exposure Mode</b>	<p>The exposure modes include:</p> <p><b>Auto:</b> The system performs auto exposure based on the monitoring environment.</p> <p><b>Manual:</b> You can adjust the brightness of an image by setting the following: <b>Shutter Setting, Iris Setting and Gain Setting.</b></p> <p><b>Shutter Priority:</b> You can set <b>Shutter Setting</b> to fixed values. The iris and gain are automatically adjusted by the system.</p> <p><b>Iris Priority (for high-speed dome):</b> You can set <b>Iris Setting</b> to fixed values. The shutter and gain are automatically adjusted by the system.</p> <p><b>Gain Setting:</b> auto and manually to adjust.</p>	<p>[Setting method] Select a value from the drop-down list. [Default value] <b>Auto</b></p>
<b>Max Shutter</b>	<p>The device automatically adjusts the shutter time based on the ambient brightness. The shutter time is less than or equal to the value of this parameter.</p>	<p>[Setting method] Select a value from the drop-down list. [Default value] <b>1/25</b></p>
<b>Max Gain</b>	<p>The device automatically adjusts the gain based on the external light. The gain is less than or equal to the value of this parameter.</p>	<p>[Setting method] Drag the slider. [Default value] <b>50</b></p>

Parameter	Meaning	Configuration Method
<b>Iris</b>	<p>It is used to control the light admitted to the lens. The auto iris can be set to either of the following states:</p> <p><b>Auto</b> The iris is automatically adjusted to control the light admitted to the lens.</p> <p><b>Open fully</b> The iris is fully open.</p>	<p>[Setting method] Select a value from the drop-down list. [Default value] <b>Auto</b></p>
<b>Fixed Gain</b>	<p>When the exposure Mode is Manual, you can set the fixed gain.</p>	<p>[Setting method] Drag the slider. [Default value] <b>50</b></p>

Step 3 Click **Apply** to save the setting.

---End

### 3.3.6 White Balance Setting

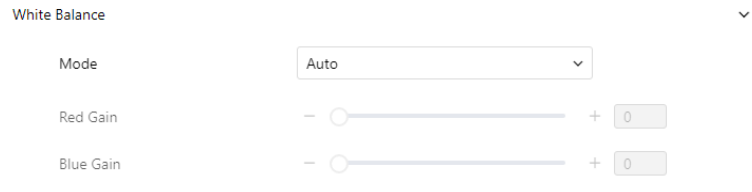

Step 1 Choose **Setting > Quick Start > Display > White Balance** tag on display interface,  
Figure 3-9 shows the **White Balance** interface.

Figure 3-9 White balance settings page



Step 2 Set the parameters according to Table 3-6.

Table 3-6 Parameters of WB setting

Parameter	Meaning	Configuration Method
<b>Mode</b>	<p>Select WB mode according to different scenes for better image color reproduction.</p> <p><b>Auto:</b> In automatic white balance (WB) mode, the system automatically performs white balance based on the monitoring environment.</p> <p><b>Tungsten</b></p> <p><b>Fluorescent</b></p> <p><b>Daylight</b></p> <p><b>Shadow</b></p> <p><b>Manual:</b> In manual WB mode, you can manually select a WB mode based on the monitoring environment.</p>	<p>[Setting method] Select a value from the drop-down list. [Default value] <b>Auto</b></p>
<b>Red Gain</b>	<p>It indicates the gain applied to red channels. As the value increases, the color temperature becomes lower.</p> <p> <b>NOTE</b> This parameter is valid when <b>Manual Mode</b> is set to <b>Customized</b>.</p>	<p>[Setting method] Drag the slider. [Default value] <b>0</b></p>
<b>Blue Gain</b>	<p>It indicates the gain applied to blue channels. As the value increases, the color temperature becomes higher.</p> <p> <b>NOTE</b> This parameter is valid when <b>Manual Mode</b> is set to <b>Customized</b>.</p>	<p>[Setting method] Drag the slider. [Default value] <b>0</b></p>

Step 3 Click **Apply** to save the setting.

----End

### 3.3.7 Day/Night

Step 1 Choose **Setting > Quick Start > Display > Day/Night** tag on display interface. The day night mode settings vary based on device models. For details, see the following sections.

Figure 3-10 shows the **Day/Night** interface.

Figure 3-10 Day/Night page (timer)

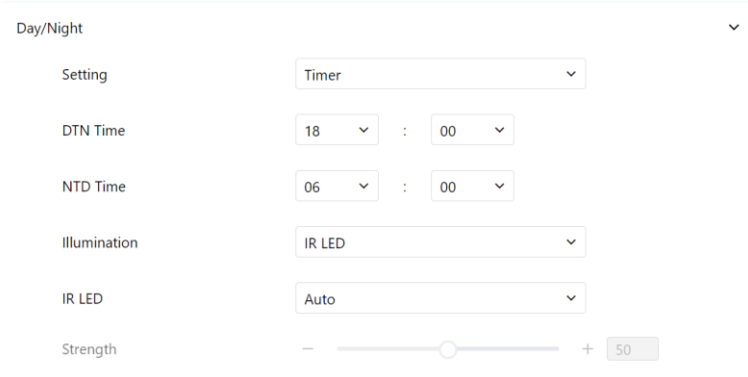
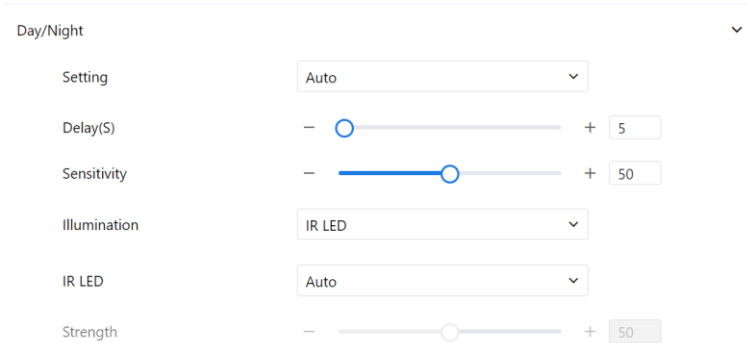





Figure 3-11 Day/Night mode page (auto)



Step 2 Set the parameters according to Table 3-7.

Table 3-7 Parameters of Day/Night

Parameter	Meaning	Configuration Method
<b>D/N Setting Mode</b>	It can be set to <b>Auto</b> , <b>Day</b> , <b>Night</b> or <b>Timer</b> .  Auto mode  The image color and filter status are automatically switched based on the ambient	[Setting method] Select a value from the drop-down list. [Default value]

Parameter	Meaning	Configuration Method
	<p>brightness. The filter keeps infrared light from reaching the sensor during the day; The filter allows all light to reach the sensor at night.</p> <p>Day mode</p> <p>The image is colored, and the filter is in the day state, preventing infrared light from entering the sensor.</p> <p>Night mode</p> <p>The image is black and white, and the filter is in the night state, allowing infrared light to enter the sensor.</p> <p>Timer</p> <p>Switching between day mode and night mode according to the set time.</p>	<b>Auto</b>
<b>D/N Switch Sensitivity</b>	<p>The sensitivity of switching day and night. The higher value of sensitivity, and the lower light intensity will switch to day.</p> <p> <b>NOTE</b></p> <p>This parameter is valid in auto mode.</p>	<p>[Setting method] Drag the slider. [Default value] <b>50</b></p>
<b>Delay(s)</b>	<p>The delay time of day to night or night to day.</p> <p> <b>NOTE</b></p> <p>This parameter is valid in auto mode.</p>	<p>[Setting method] Drag the slider. [Default value] <b>0</b></p>
<b>Illumination</b>	<p>For different models, you can choose the light modes, such as IR LED, White LED, Intelligent dual light (there are two lights in camera, IR LED and white LED), and none. It depends on performance of cameras.</p>	<p>[Setting method] Select a value from the drop-down list.</p>
<b>IR LED</b>	<p><b>Auto:</b> The infrared lamp is enabled or disabled based on the external environment identified by the light dependent resistor (LDR).</p> <p><b>ON:</b> The system enters the night mode forcibly.</p> <p><b>OFF:</b> The infrared lamp is disabled. The filter and image color are switched based on the external environment identified by the LDR.</p> <p> <b>NOTE</b></p> <p>This parameter is valid in auto mode.</p>	<p>[Setting method] Select a value from the drop-down list. [Default value] <b>Auto</b></p>

Parameter	Meaning	Configuration Method
<b>Strength</b>	Strength of IR LED, as the value increases, the image becomes brighter.	[Setting method] Drag the slider. [Default value] <b>50</b>
<b>DTN Time</b>	Time of day to night.	[Setting method] Select a value from the drop-down list. [Default value] <b>18:00</b>
<b>NTD Time</b>	Time of night to day.	[Setting method] Select a value from the drop-down list. [Default value] <b>6:00</b>

### Fill light settings

The camera fill light has four modes, including intelligent dual light (the current fill light will switch to warm light after an alarm is triggered, and switch back to the original fill light for fill light 30s after the alert is released.), warm light, infrared lamp and close (Choose to close the fill light and the color of image will stay in the previous mode).

Different cameras can be set in different fill light modes, please set them according to the actual scene.

**Day mode:** It can be used in the scene with sufficient ambient light for 24 hours, where the image will be colorful without enabling the fill light.

**Night mode:** It can be used in a scene where there is insufficient ambient light for 24 hours, and turn on the fill light (it can be selected according to the four modes of the fill light).

**Auto mode:** Automatically switch the set fill light mode according to the brightness of the environment.

**Timer mode:** Set the start and end time of the day, this time period is in day mode.

The brightness of the supplemental light can be set to either automatic or manual. In automatic mode, it adjusts based on the current environment. In manual mode, you can adjust the brightness by dragging the slider or setting a specific value.

Step 3 Click **Apply** to save the setting.

----End

### 3.3.8 Noise Reduction

Step 1 Choose **Setting > Quick Start > Display > Noise Reduction** tag on display interface, Figure 3-12 shows the Noise Reduction interface.

Figure 3-12 Noise reduction page (auto)

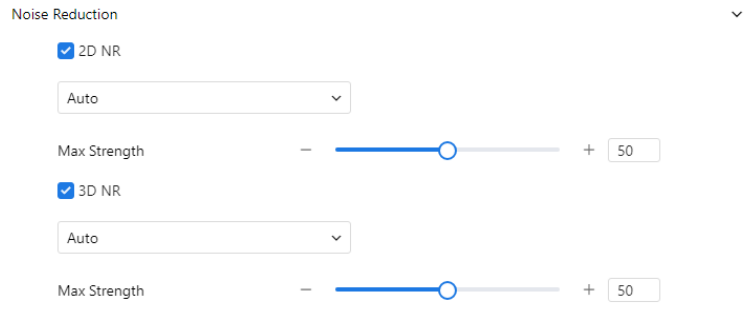
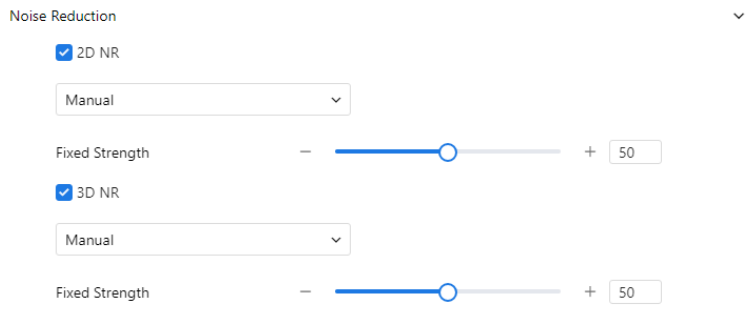

Figure 3-13 Noise reduction page (manual)



Step 2 Set the parameters according to Table 3-8.

Table 3-8 Parameters of Nositie reduction

Parameter	Meaning	Configuration Method
2D NR	Reduce noise of image.	[Configuration method] Select from the drop-down list [Default value] <b>Auto</b>
3D NR	Reduce noise of image.	[Configuration method] Select from the drop-down list [Default value] <b>Auto</b>
Max Strength	It is valid in auto noise filter mode. When the parameter value is <b>0</b> , the noise filter is disabled. When the parameter value is greater than <b>0</b> , the noise filter is enabled, and the system automatically adjusts the noise filter level based on the ambient brightness without exceeding the value of this parameter.	[Setting method] Drag the slider. [Default value] <b>50</b>
Fixed Strength	It is valid in a manual noise filter mode.	[Setting method] Drag the slider. [Default value] <b>50</b>

Step 3 Click **Apply** to save the setting.

----End

### 3.3.9 Image Enhancement

Step 1 Choose **Setting > Quick Start > Display > Image Enhancement** tag on display interface, Figure 3-14 shows the enhance image interface and Table 3-9 shows the enhance image parameters.

Figure 3-14 Image Enhancement page

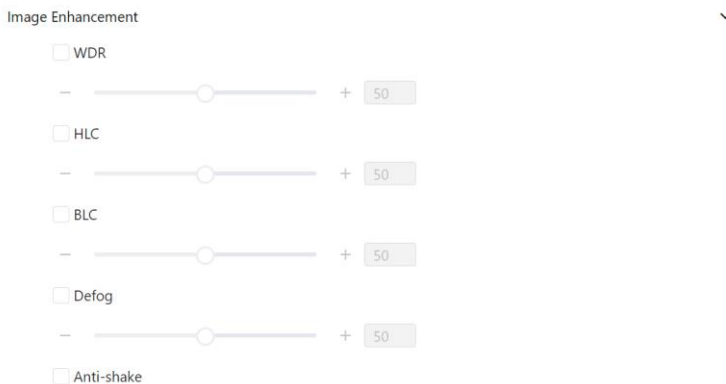

Step 2 Set the parameters according to Table 3-9.

Table 3-9 Parameters of enhance image

Parameter	Meaning	Configuration Method
WDR	It is used to display the foreground and background at the same time in the environment with a large brightness difference. When the brightness difference is larger, you can increase the WDR level to obtain better image effect.	[Setting method] Tick the WDR mode and drag the slider. [Default value] <b>50</b>
HLC	It provides a clearer view of an image in the highlight environment. When HLC is enabled, the total brightness of an image is reduced, allowing you to view objects in front of the highlight.	[Setting method] Tick the HLC mode and drag the slider. [Default value] <b>50</b>
BLC	It provides a clearer view of an image in the backlight environment. When BLC is enabled, the total brightness of an image increases, allowing you to view objects in front of the backlight. Meanwhile, the objects behind the backlight are exposed excessively.	[Setting method] Tick the BLC mode and drag the slider. [Default value] <b>50</b>
Anti-shake	The shakes and visual angle of image will reduce when the camera shakes slightly and the anti-shake is enable.	[Setting method] Tick the Anti-shake mode.

Parameter	Meaning	Configuration Method
Defog	It provides a clearer view of an image in the fogged environment when Defog is enabled. As the value increases, the image becomes clearer. Only apply for some models.	[Setting method] Tick the Defog mode and drag the slider. [Default value] <b>50</b>
Anti-shake	The shakes and visual angle of image will reduce when the camera shakes slightly and the anti-shake is enable.	[Setting method] Tick the Anti-shake mode.

Click **Apply** to save the setting.

----End

## 3.4 Thermal Channel Display

### 3.4.1 Mode

Step 1 Choose **Setting > Quick Start > Display**, the channel chosen 2, choose **Edit Settings**  
Click **Mode** tag on Display Settings interface, the Mode page is displayed, as shown in Figure 3-15.

Figure 3-15 Mode page

The screenshot shows the 'Mode' settings interface. At the top, the word 'Mode' is displayed on the left and a downward arrow on the right. Below this, there is a 'Switch Mode' button and a dropdown menu currently showing 'None'. Underneath, there are two rows of time settings: 'Start Time' with two dropdowns set to '00' and '00', and 'End Time' with two dropdowns set to '24' and '00'.

Step 2 Set the Mode parameters.

Step 3 Click save to save the setting.

----End

### 3.4.2 Image

Figure 3-16 shows the image interface.

Figure 3-16 Image interface



Table 3-10 describes the image setting parameters.

Table 3-10 Image setting parameter description

Parameter	Description	Setting
Brightness	It indicates the total brightness of an image. As the value increases, the image becomes brighter.	[Setting method] Drag the slider. [Default value] <b>50</b>
Detail Enhancement	Adjust the details and edges of higher temperature image.	[Setting method] Drag the slider. [Default value] <b>50</b>
Contrast	It indicates the contrast between the bright part and the dark part of an image. As the value increases, the contrast increases.	[Setting method] Drag the slider. [Default value] <b>50</b>
Sharpness	It indicates the sharpness of the image plane and the sharpness of the image edge. The clearer image, the better detail contrast.	[Setting method] Drag the slider. [Default value] <b>50</b>

----End

### 3.4.3 Scene

Figure 3-17 shows the scene interface.

Figure 3-17 Scene interface

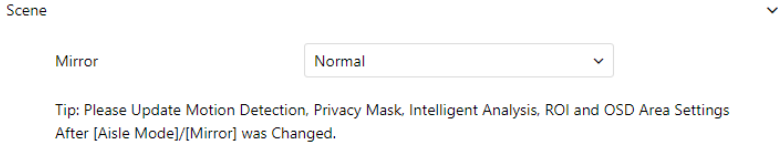

Provide the selection of image pixel locations.

**Normal:** the image is not flipped.

**Horizontal:** the image is flipped left and right.

**Vertical:** the image is flipped up and down.

**Horizontal + Vertical:** the image upside-down and reversal.

### 3.4.4 Set Pseudocolor

Figure 3-18 shows the Set Pseudocolor interface.

Figure 3-18 Set Pseudocolor interface

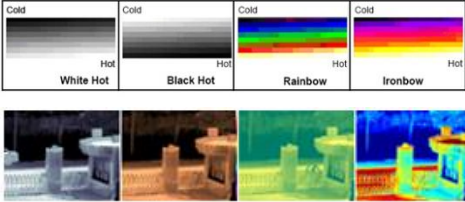

Table 3-11 Pseudocolor parameter

Parameter	Description	Setting
Pseudo-Colors	<p>Polarity/LUT: the temperatures of the temperature fields detected by the thermal imaging camera are separately mapped to values ranging from 0 to 255 by the algorithm. In the black/white display mode, this range is converted to the grayscale tones. For example, 0 indicates completely black, and 255 indicates completely white. The temperature field of the scene is converted to images by using the grayscale ranging from 0 to 255. Different polarity modes can be converted to different display images. The most common setting is white hot (a hotter object is displayed brighter than a colder object) or black hot (a hotter object is displayed darker than a colder object). The difference between two modes lies in that the temperatures corresponding to the darker one and the lighter one is reversed. Other modes include rainbow, ironbow, HSV, autumn, bone and so on.</p> 	<p>[How to set] Select from the drop-down list box. [Default value] <b>White Hot</b></p>

Legend of Temperature Value	It is on, the live video will show, otherwise there is no legend.	[How to set] Select from the drop-down list box. [Default value] <b>Close</b>
Sync FOV	For some models, the optical lens is can be zoomed, click “Sync FOV” to adjust to a consistent field of view about two channels.	[How to set] Click
X Offset	The mix stream mode is open. The thermal image and optical-light image are mixed, if the positions of two channel is deviation, you can set the offset to adjust. X offset is adjusting left and right direction. Y offset is adjusting up and down direction.	[How to set] Drag the slider. [Default value] <b>0</b>
Y Offset		
Width Offset	Adjust the aspect ratio.	[How to set] Drag the slider. [Default value] <b>0</b>
Height Offset		

### 3.4.5 FFC Control

Figure 3-19 shows the FFC control interface.

Figure 3-19 FFC interface

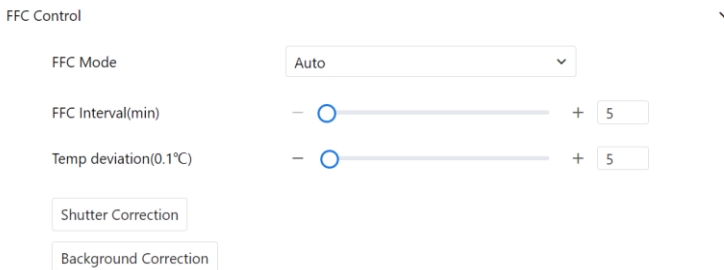

Table 3-12 describes the FFC control mode parameters.

Table 3-12 FFC control parameter description

Parameter	Description	Setting
FFC Mode	The internal of the thermal imaging camera may	[How to set]

Parameter	Description	Setting
	<p>comprise the mechanical action correction mechanism that can periodically improve the image quality. This component is called flat field correction (FFC). When controlling the FFC, the FFC shields the sensor array, so that each portion of the sensor can collect uniform temperature fields (flat field). By means of FFC, the camera can update the correction coefficients to output more uniform images. Throughout the FFC process, the video image is frozen for two seconds and a static-frame image is displayed. After the FFC is complete, the image is automatically recovered. Repeated FFC operations can prevent the grainy and image degradation problems. The FFC is especially important when the temperature of the camera changes. For example, after the camera is powered on or the ambient temperature is changed, you should immediately perform the FFC.</p> <p><b>Auto:</b> In the Automatic FFC mode, the camera performs FFC whenever its temperature changes by a specified amount or at the end of a specified period of time (whichever comes first). When this mode is selected, the FFC interval (minutes) ranges from 5 to 30 minutes. The temperature change of the camera is based on the temperatures collected by the internal temperature probe. The temperature of the camera sharply changes when the camera is powered on. The FFC is relatively frequent, which is normal.</p> <p><b>Manual:</b> In the manual FFC mode, the camera does not automatically perform the FFC based on the temperature change or the specified period. You can press the Do FFC button to select the manual FFC mode. When you feel that the image is obviously degraded but the automatic FFC is not performed, you can use the manual FFC function to check whether the image quality can be improved.</p>	<p>Select from the drop-down list box. [Default value] <b>Auto</b></p>
FFC Interval (min)	In the automatic FFC mode, the FFC interval ranges from 5 to 255 minutes.	<p>[How to set] Drag the slider. [Default value] <b>5</b></p>

Parameter	Description	Setting
Temper deviation(0.1 °C)	In the automatic FFC mode, the FFC interval ranges from 0.2 to 25.5 centigrade.	[How to set] Drag the slider. [Default value] <b>5</b>
Shutter Correction	Click the icon to adjust exposure immediately.	N/A
Background Correction	Click the icon and cover the camera with something to adjust image. Remove the thing to finish adjustment.	N/A

---End

### 3.4.6 Noise Reduction

Figure 3-20 shows the Noise Reduction interface.

Figure 3-20 Noise reduction interface

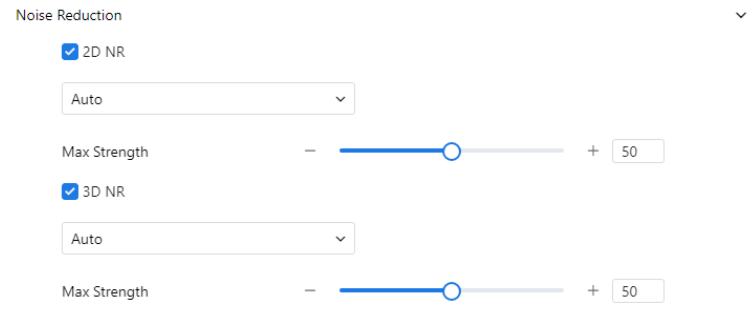

Table 3-13 describes noise reduction parameters.

Table 3-13 DNR parameter description

Parameter	Description	Setting
2 DNR	Decrease the image noise.	[How to set] Select from the drop-down list box. Drag the slider to adjust max strength. [Default value] <b>Auto</b>
3 DNR	Decrease the image noise.	[How to set] Select from the drop-down list box. Drag the slider to adjust max

Parameter	Description	Setting
		strength. [Default value] <b>Auto</b>

## 3.5 OSD

### Description

The on-screen display (OSD) function allows you to display the device name, channel ID and name, time, and other customized contents on videos. You can drag the OSD frames to anywhere you want to put.

- When the resolution is D1 and CIF, the OSD customized in web interface can show at most 22 words normally.
- The OSD support simplified Chinese, English, digital and some special character only.

### Procedure

Step 1 Choose **Setting > Quick Start > OSD**.

The **OSD** page is displayed, as shown in Figure 3-21.

Figure 3-21 OSD page

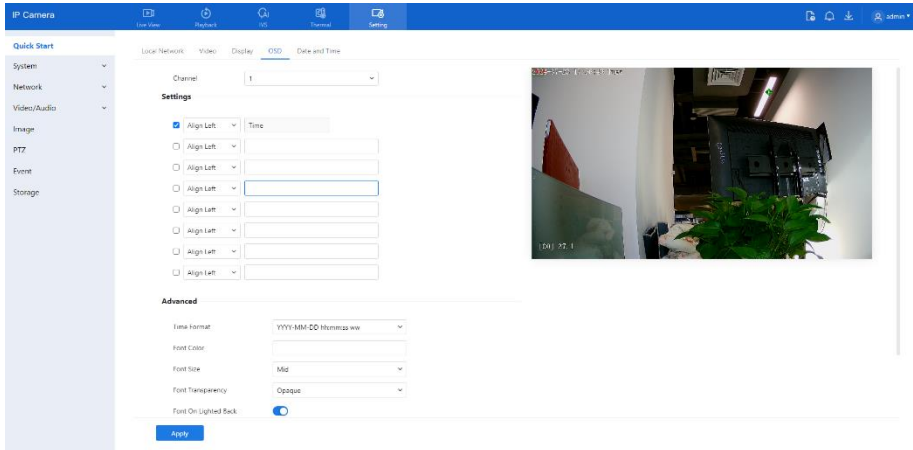

Step 2 Set the parameters according to Table 3-14.



**NOTE**

There are no more than seven OSD display areas.

Table 3-14 Parameters of OSD

Parameter	Description	Setting
Channel	Channel 1 is optical channel, channel 2 is thermal channel.	[Setting method] Select a value from the drop-down list box. [Default value] <b>1</b>
Time	Indicates whether to display the time.	[Setting method] Tick the time.
Settings	Custom OSD .Enables you to enter a line of characters.	[Setting method] 1. Tick the custom OSD list. 2. Set the position of OSD showing. Or drag the frame of OSD to adjust the position on live video. 3. Enter the characters. Click <b>Apply</b> to save the value.
Time Format	Format in which the time is displayed.	[Setting method] Select a value from the drop-down list box. [Default value] YYYY-MM-DD hh:mm:ss ww
Font Color	Set the font color.	[Setting method] Select a value from the drop-down list box. [Default value] Blank
Font Size	Set the font size.	[Setting method] Select a value from the drop-down list box. [Default value] Mid
Font Transparency	Set the font transparency.	[Setting method] Select a value from the drop-down list box. [Default value] Opaque
Font on Lighted Back	Enable the font on lighted back.	[Setting method] Click the button on to enable

Parameter	Description	Setting
		<b>Font on lighted back.</b>
Device Name	Indicates whether to display the device name.	[Setting method] Click the button on to enable <b>Device Name</b>
Twelve-hour System	The time format shows at twelve-hour system.	[Setting method] Click the button on to enable
Display Week	The week will show.	[Setting method] Click the button on to enable

Step 3 Click **Advanced**, set the parameter of “Time Format”, “Font Color”, “Font Transparency”, “Font on lighted back”, and so on.

Step 4 Click **Apply**. The message "Apply success!" is displayed and the system will save the settings.

----End

## 3.6 Date and Time

### Description

On the **Date and Time** page, you can modify the date and time. Parameters that can be set include:

- Time zone and daylight-saving time (DST)
- Date and time
- Network Time Protocol (NTP) server

### Procedure

Step 1 Choose **Setting > Quick Start > Date and Time**.

The **Date and Time** page is displayed, as shown in Figure 3-22. Table 3-15 describes the parameters.

Figure 3-22 Date and time page

Local Network Video Display OSD Date and Time

Time Zone (GMT) Greenwich Mean Time : Dublin, Edinburgh, Lisbon, London

Device Time 2024-07-24 10:37:18

Set Manually 2024-07-24 10:37:13

Synchronize with PC time

NTP

Daylight Savings Time

Begin Time Mar 5Th Sun 1:00AM

End Time Oct 5Th Sun 2:00AM

Apply

Table 3-15 Parameters of date and time

Parameter	Description	Setting
Time Zone	N/A	[Setting method] Select a value from the drop-down list box. [Default value] Greenwich mean time
Device Time	Device display time.	[Setting method]  Synchronize the time from the PC. Enter a value manually.
Set Manually	You can set the device time manually or synchronize with PC time.	[Setting method] Click <b>Set Manually</b> and set the date and time in the format <i>YYYY-MM-DD HH:MM:SS</i> .
NTP	IP address or domain name of the NTP server.	[Setting method] Click the button on to enable <b>NTP</b> and enter a value manually.
Server Address	NTP is enabled. The NTP server IP.	[Setting method] Enter a value manually.

Parameter	Description	Setting
Port	NTP is enabled. Port number of the NTP server.	[Setting method] Enter a value manually. [Default value] <b>123</b>
Interval	NTP is enabled. Set time interval to check if the device time synchronizes with the NTP server time.	[Setting method] Enter a value manually. [Default value] <b>60</b>
Daylight Saving Time	When the DST start time arrives, the device will automatically be one hour earlier. When the DST end time arrives, the device will automatically be one hour later.]\	[Setting method] Click the button on to enable <b>Daylight Saving Time</b> .

Step 2 Click **Apply**. The message "Apply success!" is displayed and the system will save the settings.

----End

## 4 Configuring Thermal

---

### 4.1 Settings

#### 4.1.1 Temperature Parameters

Temperature parameters include temperature unit, ambient type, ambient temperature, cavity temperature, correctional coefficient, area temperature display mode, area temperature type, measure mode, area alarm interval and so on.

#### Operation Procedure

Step 1 Choose **Thermal > Settings > Temperature Parameters**.

The **Temperature Parameters** page is displayed, as shown in Figure 4-1.

Figure 4-1 Temperature Parameters Interface

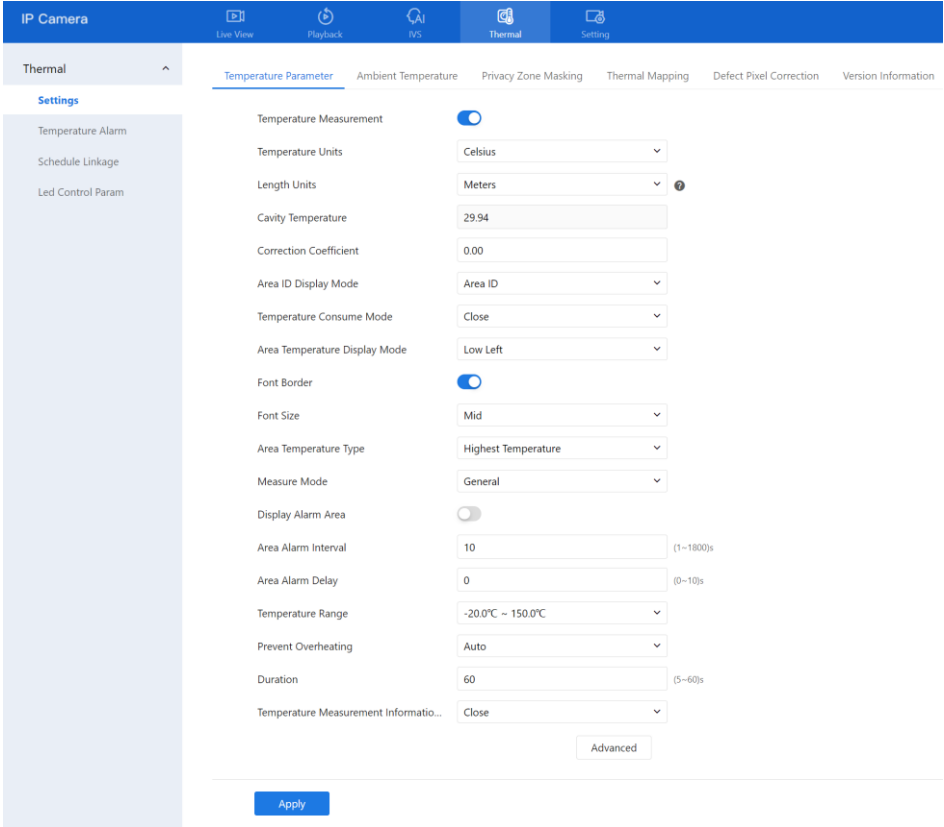

Step 2 Set the parameters according to Table 4-1.

Table 4-1 Temperature Parameters

Parameter	Description	Setting
Temperature Measurement	It is default enabling. If it is disable, the thermal channel cannot be working.	[Default value] <b>Enable</b>

Parameter	Description	Setting
Temperature Units	Celsius and Fahrenheit temperature units are available.	[Setting method] Select a value from the drop-down list box. [Default value] <b>Celsius</b>
Length units	Meters and feet length units are available.	[Setting method] Select a value from the drop-down list box. [Default value] Meters
Cavity Temperature	The cavity temperature of camera.	N/A
Correction Coefficient	<p>Correction coefficient is refer to the deviation of measured object temperature and actual temperature, is offset value.</p> <p>For example:</p> <ol style="list-style-type: none"> <li>1. The measured object temperature is 20, and actual temperature is 20.5, so the correction coefficient should be <b>0.5</b>.</li> <li>2. The measured object temperature is 20, and actual temperature is 19.5, so the correction coefficient should be <b>-0.5</b>.</li> </ol> <p>NOTE</p> <p>User should contact the technical support staff of our company at this condition to make sure to apply</p>	[Setting method] Enter a value manually. [Default value] <b>0.00</b>
Area ID display mode	There two mode to display, area ID and area name	[Setting method] Select a value from the drop-down list box. [Default value] <b>Area ID</b>

Parameter	Description	Setting
Temperature Consume Mode	Transfer temperature values or images to third-party platforms via SDK(Software development kit) protocol. You can get a custom SDK from the manufacturing company if needs.	[Setting method] Select a value from the drop-down list box. [Default value] <b>Close</b>
Area Temperature Display Mode	The display position of temperature information on the live-video image.	[Setting method] Select a value from the drop-down list box. [Default value] <b>Low left</b>
Font Border	Enable to bold the font	[Setting method] Enable or disable [Default value] <b>Disable</b>
Font size	There are three font size can be chosen, small/mid/big	[Setting method] Enable or disable [Default value] <b>Mid</b>
Area Temperature Type	There are three types of area temperature.	[Setting method] Select a value from the drop-down list box. [Default value] <b>Highest Temperature</b>
Measure Mode	There are two types of measure modes. Preset or general.	[Setting method] Select a value from the drop-down list box. [Default value] <b>General</b>
Display Alarm Area	Tick, the setting alarm area will display on live video.	[Setting method] Enable or disable [Default value] <b>Disable</b>

Parameter	Description	Setting
Area Alarm Interval	During the interval, the same alarm will only be sent once.	[Setting method] Enter a value manually ranges from 1 to 1800. [Default value] <b>10</b>
Area Alarm delay	The area alarm information will delay for setting time.	[Setting method] Enter a value manually ranges from 1 to 10. [Default value] <b>10</b>
Temperature range	It depends on the device. Different devices have different modes, there are two ranges, such as -20 °C - 150°C, -40 °C-150°C. The thermal imaging box network camera is - 40 °C-150°C.	[Setting method] Select a value from the drop-down list box.
Prevent Overheating	Open, if temperature of the testing area is too high, you can enable it to prevent over heat function. The control cover will be lay down to keep the detector safe. There are two types, manual and auto.	[Setting method] Select a value from the drop-down list box.
Duration	Prevent over heat' mode is auto, the control cover will block for duration time automatically if over heat.	[Setting method] Enter a value manually ranges from 5 to 60.
Temperature Measurement Information	If it is on, the live video of thermal channel will be mapping with optical channel. The effect will show on optical channel.	[Setting method] Select a value from the drop-down list box

Figure 4-2 Advanced Interface

Advanced

Dimming Mode Auto ▾

Greater Prominent

Section Prominent

Less Prominent

Raw Data Upload Interval(F/S) 1 ▾

Mix Stream Mode Close ▾

---

Apply

Table 4-2 Advance Parameters

Parameter	Description	Setting
Dimming Mode	There are auto and manual modes. Auto: It will show on temperature item depending on the full screen temperature. Manual: it will show on the manual value.	[Setting method] Select a value from the drop-down list box. [Default value] <b>Auto</b>
Greater Prominent	Enable that, the image will show the setting color if the temperature is higher than set value.	[Setting method] Enter a value manually. Choose one color to show.
Section Prominent	Enable that, the image will show the setting color if the temperature is between minimum and maximum temperature.	[Setting method] Enter a value manually. Choose one color to show.
Less Prominent	Enable that, the image will show the setting color if the temperature is lower than set value.	[Setting method] Enter a value manually. Choose one color to show.

Parameter	Description	Setting
Raw Data Upload Interval(F/S)	Interval of uploading the raw data.	[Setting method] Select a value from the drop-down list box. [Default value] <b>1</b>
Mix Stream Mode	This function is used for mixing thermal and visible imaging, if you want to adjust the location, please set at thermal channel “ Setting > Display > Pseudocolor” tab interface. There are close, mode 1 mode 2, and mode 3. The different models maybe have different displays; Please refer to the actual product.	[Default value] <b>Close</b>

Step 3 Click **Apply**. The message "Apply success!" is displayed and the system will save the settings.

---End

## 4.1.2 Ambient Temperature

Step 1 Choose **Thermal > Settings > Ambient Temperature**.

Figure 4-3 Ambient Temperature

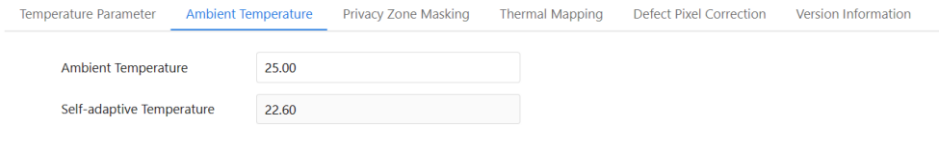

Table 4-3 Parameter of Ambient Temperature

Parameter	Description	Setting
Ambient Temperature	Environment temperature of camera.	[Setting method] Enter the temperature of ambient environment. [Default value] <b>25</b>

Parameter	Description	Setting
Self-adaptive Temperature	Set the ambient temperature, click “Apply”, the camera will get the value automatically.	---

Step 2 Click **Apply**. The message "Apply success!" is displayed and the system will save the settings.

----End

### 4.1.3 Privacy Zone Masking

Privacy zone masking is meaning that the camera will do not detect the temperature of that area. The shield areas can be set up to eight areas.

Operation Procedure

Step 1 Choose **Thermal > Settings > Privacy Zone Masking**.

Figure 4-4 Privacy Zone Masking

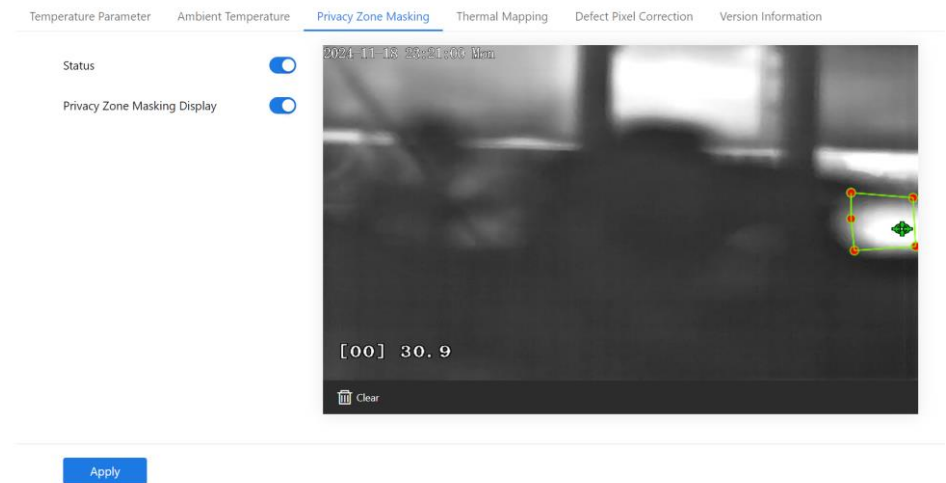

Step 2 Enable the privacy zone masking.

Step 3 Enable Show Privacy Zone Masking Display, then the setting shield will show on live video.

Step 4 Click-left mouse button to set area; Click-right mouse button to end the setting.

Step 5 Click **Clear** to clear the setting area.

Step 6 Click **Apply** to save.

---End

### 4.1.4 Thermal Mapping

Thermal mapping is used to map accurately the location of detecting area to the optical channel. The mapping has three points, user can choose the right locations to map, the three points should not be too close.

 **NOTE**

The images have been calibrated before leaving the factory and can be used directly. If the highest temperature detection points are deviating on the visible light image, it needs to be re-calibrated.

#### Operation Procedure

Step 1 Choose **Thermal > Settings > Thermal Mapping**, as shown in Figure 4-5.

Figure 4-5 Thermal Mapping Interface

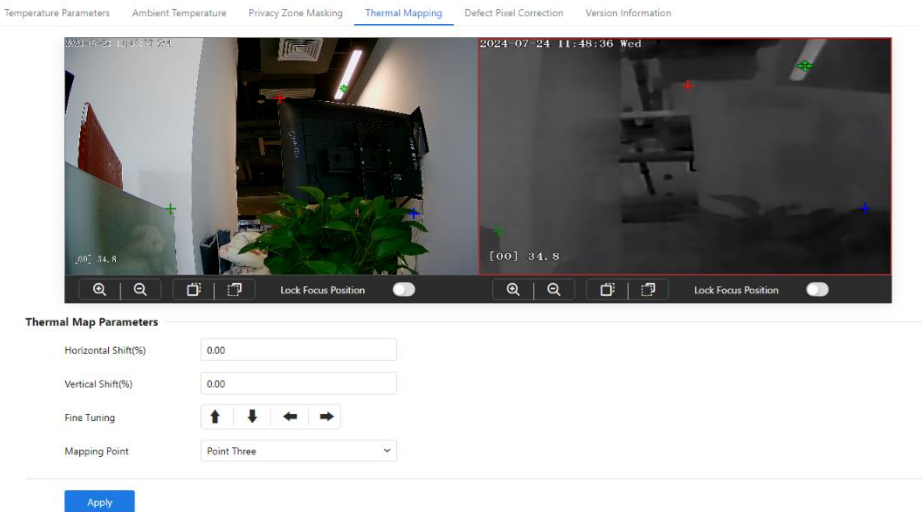

Step 2 Settings please refer to Table 4-4.

Table 4-4 Parameter of Thermal Mapping

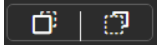
Parameter	Description	Setting
	Zoom in / zoom out	[Setting method] Click
	Near focus / far focus	[Setting method] Click
Lock focus position	Users adjust the position for mapping to lock this position	[Setting method] Enable
Horizontal shift(%)	Adjust horizontal position of area which is on visual image.	[Setting method] Input value
Vertical shift(%)	Adjust vertical position of area which is on visual image.	[Setting method] Input value
Fine turning	Click the icon to adjust the position trifle.	[Setting method] Click
Mapping point	You need map three points at two channels. Points are correspond of each. The three points should cover most areas, and two points are located in the diagonal display of the picture. Point one is green cross. Point two is red cross. Point three is blue cross.	[Setting method] Select from drop list .

Step 3 Click **Apply**. The message "**Apply success**" is displayed, the system will save the settings.

---End

## 4.1.5 Defect Pixel Correction

### Operation Procedure

Step 1 Choose **Thermal > Settings > Defect Pixel Correction**.

The **Defect Pixel Correction** page is displayed, as shown in Figure 4-6.

If the image has a white dot as shown in figure, user can test the function to recover the defect pixel. Users should connect the technical support at this condition to make sure to apply.

Figure 4-6 Defect pixel correction

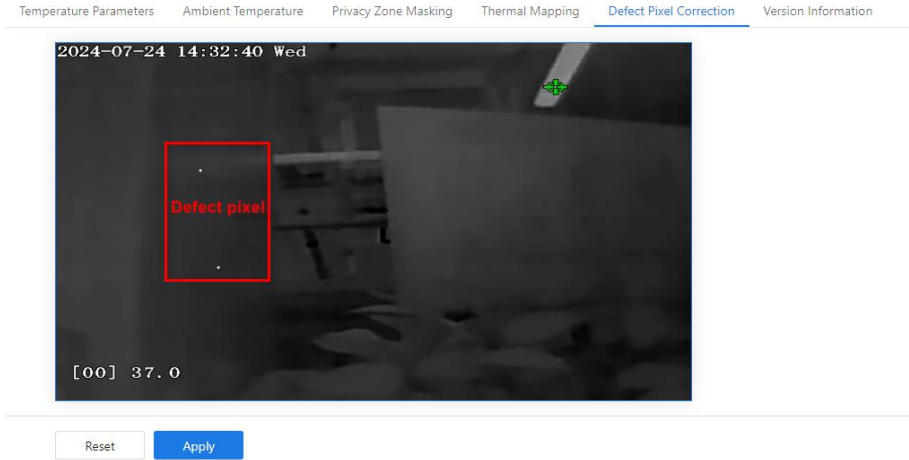

Step 2 Click the white point at image, click **Refresh** to recover the defect pixel, as shown in Figure 4-7.

Figure 4-7 Recover Defect Pixel



Step 3 Click **Apply**. The message "Apply success" is displayed, the system will save the settings.

---End

## 4.1.6 Version Information

Check the MCU version and MCU sequence number for easy traceability

# 4.2 Temperature Alarm

Operation Procedure

Step 1 Choose **Thermal > Temperature Alarm**.

The **Temperature Alarm** page is displayed, as shown in Figure 4-8.

Figure 4-8 Temperature Area and Alarm Configuration

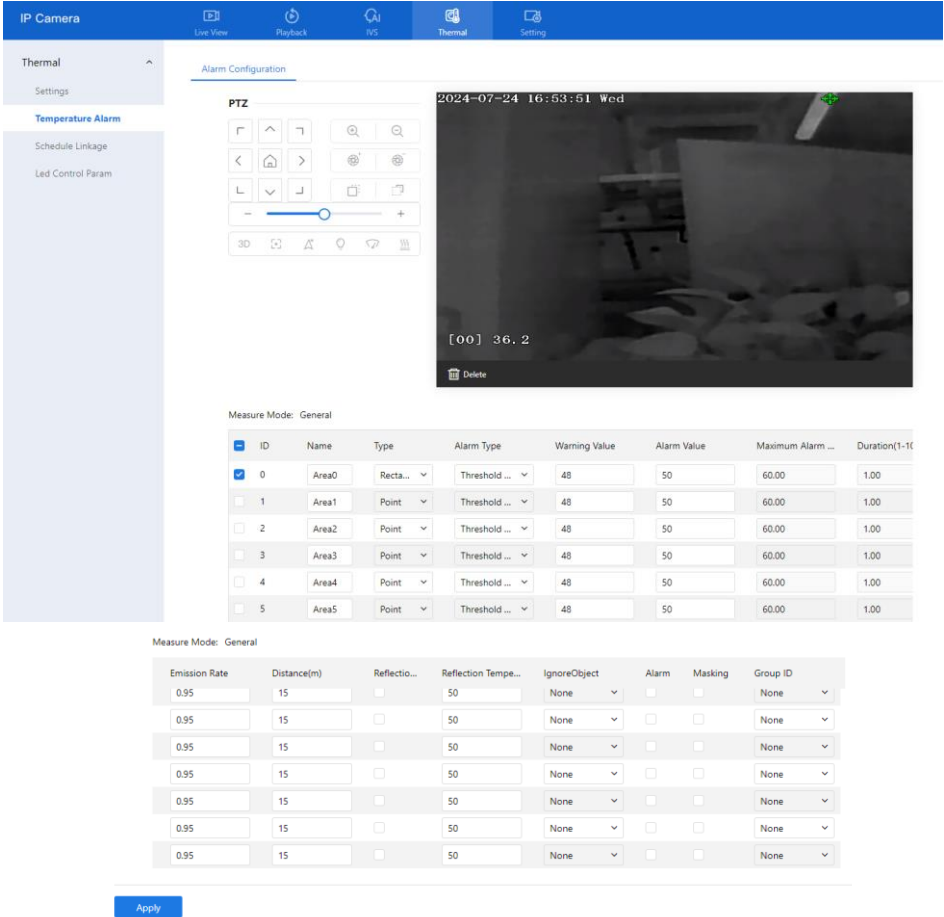

Step 2 Set the parameters according to Table 4-5.

Table 4-5 Alarm configuration

Parameter	Description	Setting
Measure Mode	Set at temperature parameter interface.	N/A
Enable	Tick the ID to enable the area measuring.	[Setting method] Tick
Name	Area name of temperature area.	[Setting method] Enter a value manually.

Parameter	Description	Setting
Type	Type of temperature area. ID 0 is default rectangle area, which is full screen, it cannot be modified. Other IDs can be set point / line/ polygon.	[Setting method] Select a value from the drop-down list box. [Default value] <b>Rectangle/Point</b>
Alarm Type	Threshold alarm, temperature difference alarm, section alarm, temperature rise alarm are available for the alarm type. Section Alarm: if the temperature value is among the set temperature range, it will generate the alarm. Temperature rise alarm means it the rising temperature value is more than the set value, it will generate the alarm.	[Setting method] Select a value from the drop-down list box. [Default value] <b>Threshold alarm</b>
Warning Value	Camera will trigger warning alarm when the object temperature reaches the warning value.	[Setting method] Enter a value manually. [Default value] <b>48</b>
Alarm Value	Camera will alarm when the object temperature reaches the alarm value.	[Setting method] Enter a value manually. [Default value] <b>50</b>
Maximum Alarm Value	At section alarm type, the device would not alarm when the temperature is higher than maximum alarm value.	[Setting method] Enter a value manually. [Default value] <b>60.00</b>
Duration (1-10S)	Choose temperature rise alarm, set the duration. the temperature value rises within duration setting, the alarm is triggered successfully.	[Setting method] Enter a value manually. [Default value] <b>1.00</b>
Emission Rate	The emission rate is the capability of an object to emit or absorb energy. The emission rate should be set only when the target is special material.	[Setting method] Enter a value manually. [Default value] <b>0.95</b>

Parameter	Description	Setting
Distance(M)	The distance between camera and target.	[Setting method] Enter a value manually. [Default value] <b>15</b>  <b>NOTE</b> Enter actual distance when the distance between camera and target is less than 15m. Enter 15 when the distance between camera and target is great than or equal to 15m.
Reflect Enable	When there are some high temperature objects on scene, and the temperature reflect to the other object, you can enable this function to calibrate the temperature.	[Setting method] Tick to enable
Reflect Temperature	The temperature of high temperature object.	[Setting method] Enter a value manually. [Default value] <b>50.00</b>
Ignore Object	Enable to shield the temperature of area capturing AI object.	[Setting method] Select a value from the drop-down list box.
Alarm	Enable or disable the alarm output and linkage of area.	[Setting method] Tick to enable alarm.
Masking	Enable, the device will shield this area's temperature.	[Setting method] Tick to shield.

Parameter	Description	Setting
Group ID	<p>The ID can be chosen into one of six groups, or no group. The group will be alarm following as the next rules:</p> <p>A=The highest temperature of groups (the highest temperature of N regions is the largest)</p> <p>B=Average temperature of groups (average temperature of N regions)</p> <p>WA=Warning value</p> <p>AA=Alarm value</p> <p>a. If <math>A - B \geq WA</math>, a temperature difference warning signal is generated ---&gt; (the one with the largest difference between the N areas and the average temperature is the alarm area flashing)</p> <p>b. If <math>A - B \geq AA</math>, a temperature difference alarm signal is generated ---&gt; (the one with the largest difference between the N areas and the average temperature is the alarm area flashing)</p> <p>c. If the warning and alarm conditions are met at the same time, the alarm signal will be generated first.</p>	<p>[Setting method]</p> <p>Select a value from the drop-down list box.</p>

Step 3 Set temperature area.

1. Tick an area ID. Set the name.
2. Choose the type (point, line, polygon)
3. Press and hold the left mouse button, and drag in the video area to draw a temperature area, as shown in Figure 4-9. Right-click to finish the area selected.

Figure 4-9 Temperature Area Setting Interface

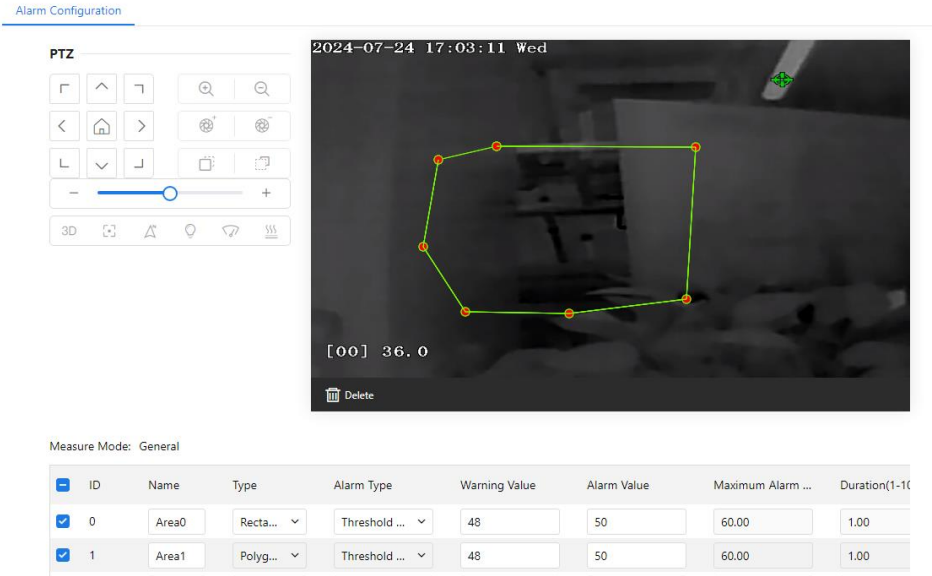



Step 4 Click **Apply**, the message “Apply success” is displayed, the temperature area is set successfully.

 **NOTE**

ID 0 is the full screen; The area cannot be changed.

 : the lowest temperature of the full screen.

 :the highest temperature of the full screen.

 : the lowest temperature of the area.

 : the highest temperature of the area.

Step 5 Delete a temperature area:

1. Select an area ID.
2. Click **Clear**.
3. Remove the tick of area ID.
4. Click **Apply**, the message “Apply success” is displayed, the temperature area is deleted successfully.

Step 6 Click **Apply**. The message "Apply success" is displayed, the system will save the settings.

----End

## 4.3 Schedule Linkage

### Operation Procedure

Step 1 Choose **Thermal > Schedule Linkage**.

There are seven type alarm linkage, threshold alarm, threshold warning, temperature difference alarm, temperature difference warning, temperature section alarm, temperature rise alarm, temperature rise warning.

The **Schedule Linkage** page is displayed, as shown in Figure 4-10.

Figure 4-10 Schedule Linkage

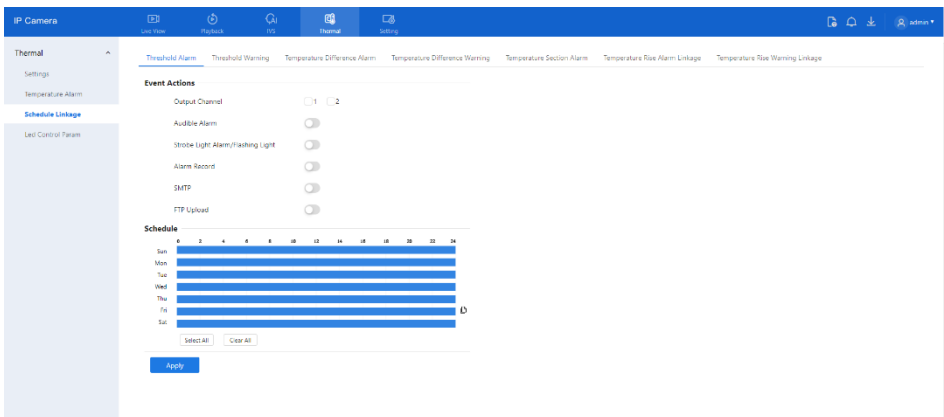

Step 2 Tick the output channel.

Step 3 Enable wanted linkage: Audible Alarm, Flashlight Alarm, Alarm Record, SMTP, FTP upload.

Step 4 Set schedule linkage.

**Method 1:** Hold down the left mouse button, drag and release mouse to select the deployment time within 0:00-24:00 from Monday to Sunday.

**Method 2:** Click **Select All** to deploy all time.

**Method 3:** set one day, click  to copy to other days.

Figure 4-11 Copy

Copy:

All

Sun

Mon

Tue

Wed

Thu

Fri

Sat

OK

**Delete schedule time:** click **Clear All** to delete all time.

Click the set time,  ~    click **Delete** to delete this time.

Step 5 The message "Apply success" is displayed, the system will save the settings.

 **NOTE**

Figure 4-12 Audio file

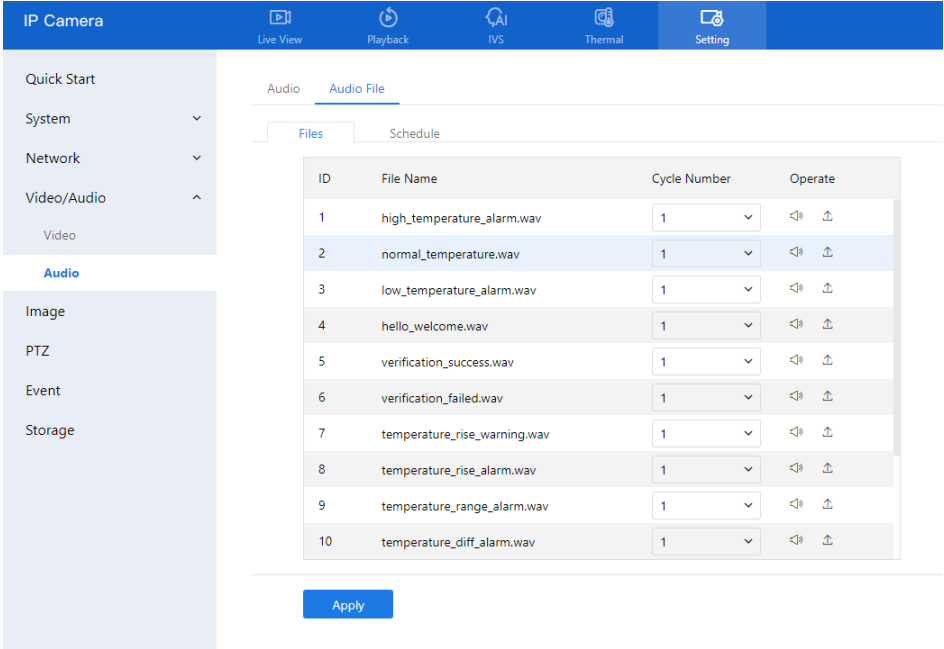

User can set the audio file manually. Click  to upload the audio file(The type should be WAV, size must be less than 250 Kb, the bit rate should be 128 kbps.), as shown in Figure 4-13.

Figure 4-13 Upload audio file



----End

## 4.4 Led Control Param

Set the display mode and brightness of LED, as shown in Figure 4-14.

Figure 4-14 LED Control Param

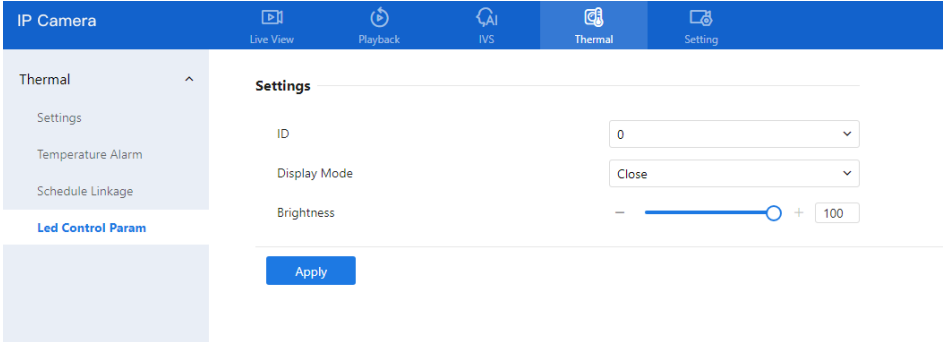

Table 4-6 LED Control Param

Parameter	Description	Setting
Display Mode	There are four modes can be chosen. Open: the LED is always lighting. Close: the LED is closed. Flicker: set the flicker interval, the LED will flicker as the set. Timing: the LED will lighting at the set time. Alarm always on: The light will be always on when alarm duration.	[Setting method] Select from drop-down list.
Brightness	The LDE's brightness	[Setting method] Drag the slider. [Default value] 100

---End

# 5 IVS Settings

At IVS (intelligent video system) page, users can set deep learning (**AI multi-target**), intelligent analysis (**intrusion, smart motion, single line crossing, double line crossing, multi-loitering, wrong-way, enter area, leave area**), environmental safety analysis ( **smoking, smoke and flame detection, fire spot detection**), behavior analysis (**people counting**).

## 5.1 AI Multi-object

Step 1 At “ IVS > AI Multiobject ” interface, user can enable full-body detection, vehicle detection to detect the person and vehicle, as shown in Figure 5-1.

Figure 5-1 AI Multiobject

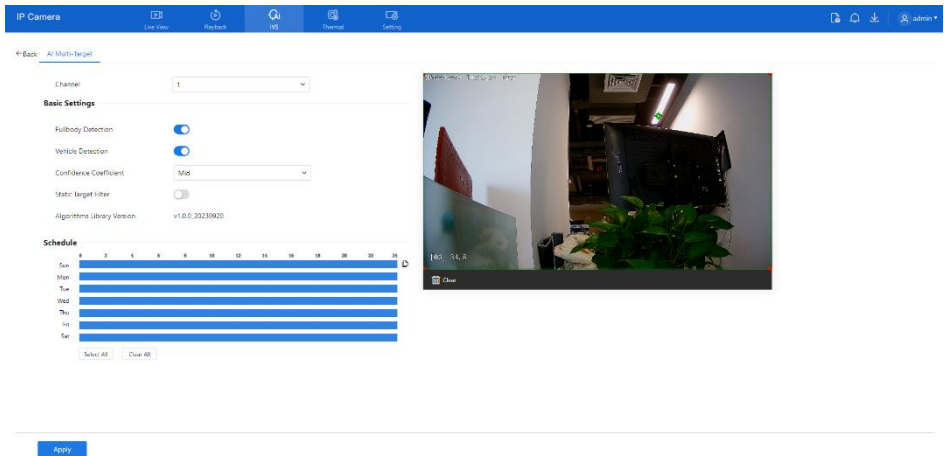

Step 2 Set the parameters of AI multiobject following as the Table 5-1 .

Table 5-1 AI multiobject parameters

Parameter	Description	How to set
Channel	Channel 1 is optical channel. Channel 2 is thermal channel.	Choose from drop list.
Full body detection	The camera will snap the whole body when someone appear in live video. The detection frame is blue.	Enable
Vehicle detection	The camera will snap the licence when the vehicle appear in live video. The detection frame is yellow.	Enable

Confidence Coefficient	The range of snapshots, there are three type, such as high, mid and low. The higher the confidence, the better the snap quality and the fewer snapshots.	Choose from drop list.
Static Target Filter	If the target is static, the device will filter this target. For example, if a car stop for long time, the device will be filtered.	Enable

Step 3 Draw the detection area by using the mouse.

Step 4 Set the schedule, please refer to chapter 4.3 Step 4.

Step 5 click “Apply” to save the settings.

---End

## 5.2 Intelligent Analysis

### 5.2.1 Intrusion

The Intrusion function refers to that an alarm is generated when target objects (such as person, car, and both person and car) enter the deployment area.

#### Procedure

Step 1 Select **IVS > Intelligent Analysis > Intrusion** to access the **Intrusion** interface, as shown in Figure 5-2.

Figure 5-2 Intrusion Setting Interface

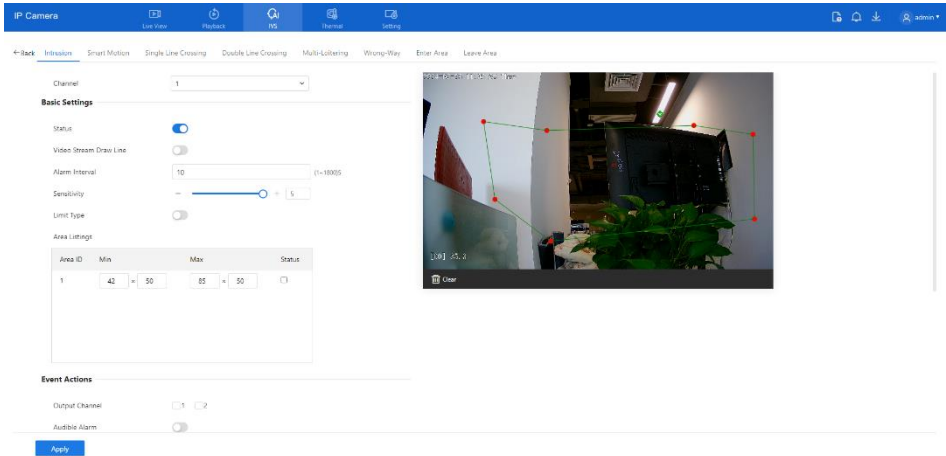

Step 2 Set all parameters for Intrusion. Table 5-2 describes the specific parameters.

Table 5-2 Intrusion Parameter Description

Parameter	Description	Setting
Channel	Channel 1: optical channel. Channel 2: thermal channel.	Choose one channel to set.
Status	Enable the button to enable the alarm.	[How to set] Click Enable to enable. [Default value] <b>OFF</b>
Video Stream Draw Line	Enable the button, the draw frame of detection will show at live video.	[How to set] Click to enable FTP Upload. [Default value] <b>OFF</b>
Alarm Interval	During the interval, the same alarm will only be sent once.	[How to set] Input a value [Default value] <b>10</b>
Sensitivity	The sensitivity of detecting smoking, when the value is high, the alarm can be triggered easily, but the accuracy will be lower.	[How to set] Choose from the drop-down list [Default value] <b>5</b>

Parameter	Description	Setting
Limit Type	Effective alarms are set based on target type, with options of Person or Car, person, car. When the device is used indoors, because of small space and large targets, to avoid wrong alarms are triggered b person even if car is selected, it is recommended to set the target type to person for indoor use.	[How to set] Click to enable Limit Target Type. [Default value] <b>OFF</b>
Area listings	When users set the areas, the area will show on listing. If the area status is on, the min and mix size will show on area, drag the frame to move, adjust the points of frame to change size.	
Output Channel	If you check to set the Output Channel and the device is connected to an external alarm indicator, the alarm indicator signals when an alarm is triggered.	[How to set] Click to select an ID.
Audible alarm	After enabling Audible Warning and setting Audible Alarm Output, the built-in speaker of the device or connected external speaker plays warning sounds when an alarm happens. (set at the “ <b>Setting &gt; Video / Audio &gt; Audio File</b> ”)	[How to set] Click to enable Audible alarm [Default value] <b>OFF</b>
Flashing light alarm	After enabling Flashing Light and setting the Flashing Light Alarm Output, the light flashes when an alarm event is detected. But when users set the display mode to Mode 5 at “ <b>IVS &gt; Thermal &gt; Led Control Param</b> ” interface, the light will be always on for 15s, not flash when it is alarm.	[How to set] Click to enable Flashlight Alarm. [Default value] <b>OFF</b>
SMTP	Enable the button to enable SMTP server.	[How to set] Click to enable SMTP. [Default value] <b>OFF</b>

Parameter	Description	Setting
FTP Upload	Enable the button to enable File Transfer Protocol.	[How to set] Click to enable FTP Upload. [Default value] <b>OFF</b>

Step 3 Set a deployment area. Move the cursor to the drawing interface and click to generate a point, move the cursor to draw a line, and then click to generate another point. This is how a line is generated. In this way, continue to draw lines to form any shape, and right-click to finish line drawing.



#### NOTE

A drawn line cannot cross another one, or the line drawing fails.  
Any shape with 32 sides at most can be drawn.  
The quantity of deployment areas is up to 8.

Step 4 Set deployment time, please refer to chapter 4.3 Step 4.

Step 5 Click **Apply** to save the settings.

---End

## 5.2.2 Smart Motion

Smart motion refers to the alert generated when a specified type of target (such as a person, car, etc.) moves within the live video defense area.

Select **IVS > Intelligent Analysis > Smart Motion** to access the **Smart Motion** interface, as shown in Figure 5-3.

Figure 5-3 Smart Motion

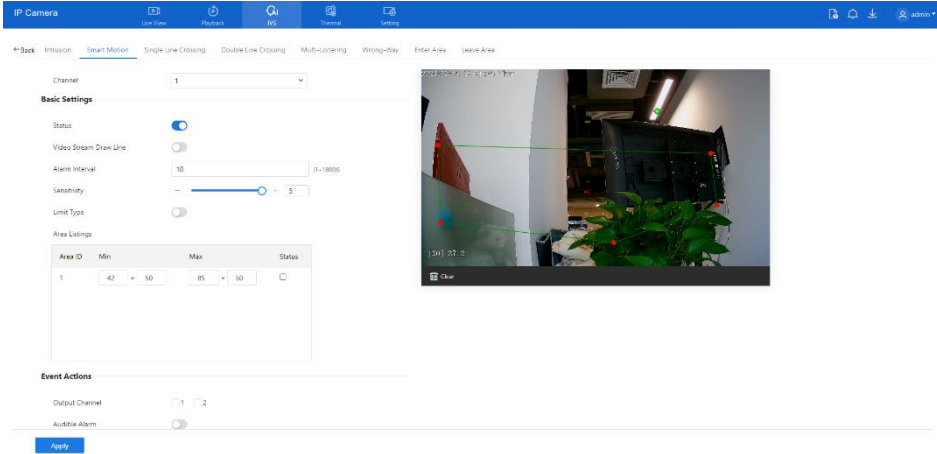

Set all parameters for smart motion, please refer to chapter 5.2.1

## 5.2.3 Single Line Crossing

A Single Line Crossing is a line that is set at a concerned position within the monitored field of view and specifies the forbidden travel direction; An alarm is generated when the targets of specified types (such as person or car) cross this line.

### Procedure

Step 1 Select **IVS > Intelligent Analysis > Single Line Crossing** to access the **Single Line Crossing** setting interface, as shown in Figure 5-4.

Figure 5-4 Single Line Crossing Setting Interface

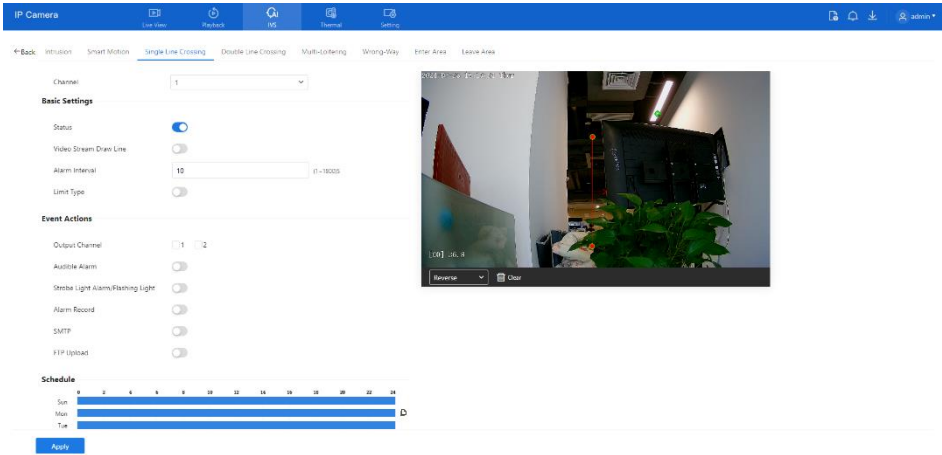

Step 2 Set all parameters for the Single Line Crossing, please refer to chapter 5.2.1 .

Step 3 Set a deployment area.

**Draw a line:** Move the cursor to the drawing interface, hold down the left mouse button, and move the cursor to draw a line. When you release the left mouse button, a Single Line Crossing is generated.

**Setting a Single Line Crossing:** Click a line (and the trip line turns red) to select the Single Line Crossing and set its direction as Positive, Reverse or Bidirectional, or delete the selected line. You can also press and hold left mouse button at the endpoint of a Single Line Crossing and move the mouse to modify the position and length of this Single Line Crossing. You can right-click to delete the Single Line Crossing.

Figure 5-5 Set Single Line Crossing line

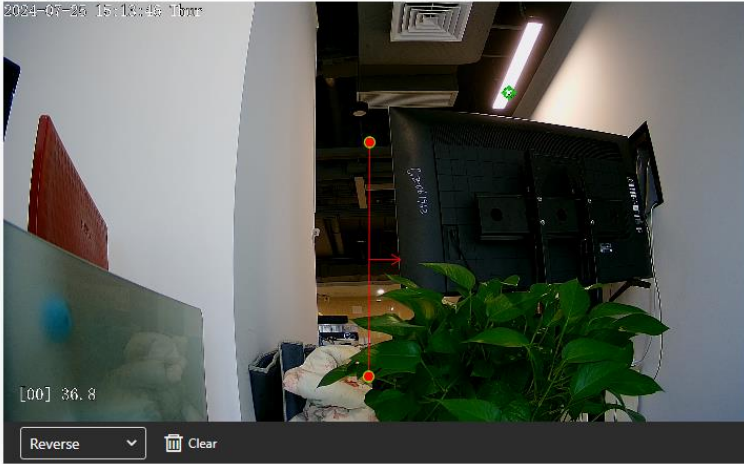

 **NOTE**

Try to draw the Single Line Crossing in the middle, because the recognition of a target takes time after target appearance on the screen and an alarm is generated only when the object is recognized to have crossed the Single Line Crossing.  
The Single Line Crossing which detects person foot as the recognition target cannot be too short, because a short Single Line Crossing tends to miss targets.

- Step 4 Set deployment time, please refer to chapter 4.3 Step 4.
- Step 5 Click **Apply** to save the settings.

---End

## 5.2.4 Double Line Crossing

Double Line Crossing refers to two lines that are set at a concerned special position within the field of view and specify the forbidden travel direction. When the targets of specified types (such as person or car) move along the set travel direction and cross these lines in a certain order (line 1 followed by line 2) in pass max time, an alarm is generated.

### Procedure

- Step 1 Select **IVS > Intelligent Analysis > Double Line Crossing** to access the **Double Line Crossing** setting interface, as shown in Figure 5-6.

Figure 5-6 Double Line Crossing Setting Interface

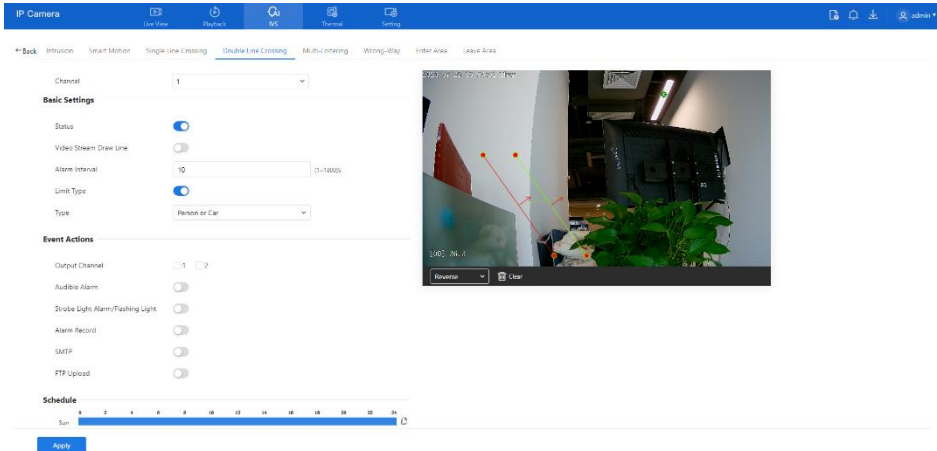

Step 2 Set all parameters for the Double Line Crossing, please refer to chapter 5.2.1

Step 3 Set a deployment area.

**Draw a line:** Move the cursor to the drawing interface, hold down the left mouse button, and move the cursor to draw two lines. When you release the left mouse button, two numbered virtual fences are generated. Choose either of the Double Line Crossing to set the direction to Positive or Reverse.

**Set Double Line Crossing:** Click one of the Double Line Crossing (and the virtual fence turns red) to select this virtual fence and set the direction to **Positive** or **Reverse**, or delete the selected line. You can also press and hold left mouse button at the endpoint of a virtual fence and move the mouse to modify the position and length of this virtual fence. You can right-click to delete the Double Line Crossing.

#### NOTE

The two lines are in sequential order. An alarm is generated only when a target crosses virtual fence 1 and then virtual fence 2 within the set maximum passing time.

Try to draw Double Line Crossing in the middle, because the recognition of a target takes time after target appearance on the screen and an alarm is generated only when the object is recognized to have crossed the Double Line Crossing.

The Double Line Crossing which detect person foot as the recognition target cannot be too short, because short Double Line Crossing tend to miss targets.

Step 4 Set deployment time, please refer to chapter 4.3 Step 4.

Step 5 Click **Apply** to save the settings.

----End

## 5.2.5 Multi-Loitering

Multi-Loitering allows setting the shortest loitering time for multiple targets of specified type (such as person or car) within the deployment area in the field of view. When the loitering time of the multiple targets within this area meets the set shortest loitering time, an alarm is generated.

Select **IVS > Intelligent Analysis > Multi-Loitering** to access the **Multi-Loitering** setting interface, as shown in Figure 5-7.

Figure 5-7 Multi-Loitering

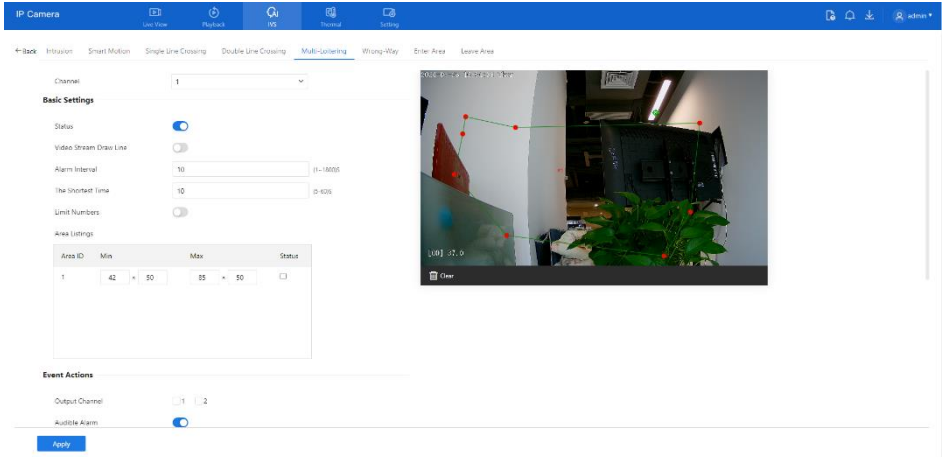

Set all parameters for multi-loitering please refer to chapter 5.2.1

## 5.2.6 Wrong -Way

Wrong-Way allows setting the travel direction criteria for a target within an area on the video screen.

Someone/something is moving towards the opposite direction in an area, an alarm is generated.

Select **IVS > Intelligent Analysis > Wrong-Way** to access the **Wrong-Way** setting interface, as shown in Figure 5-8.

Figure 5-8 Wrong-Way

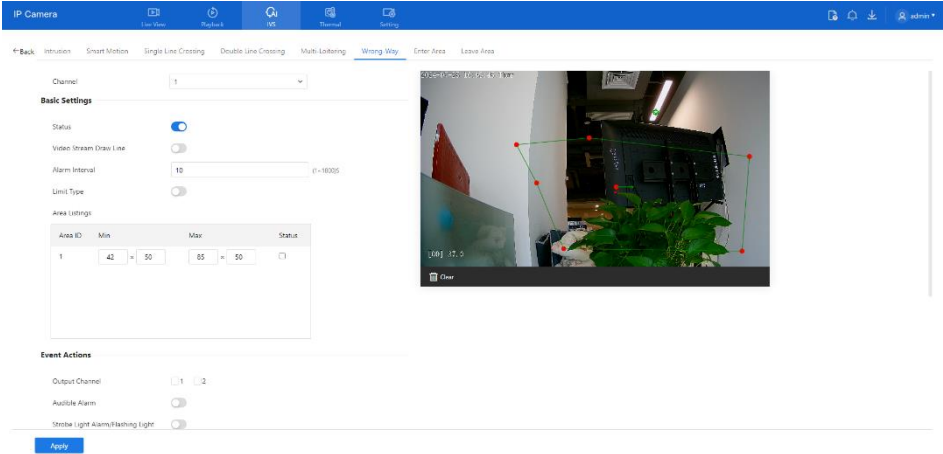

Set all parameters for wrong-way please refer to chapter 5.2.1

## 5.2.7 Enter Area

The enter area refers to that an alarm is generated when a target enters the deployment area at the valid time.

Select **IVS > Intelligent Analysis > Enter Area** to access the **Enter Area** setting interface, as shown in Figure 5-9.

Figure 5-9 Enter Area

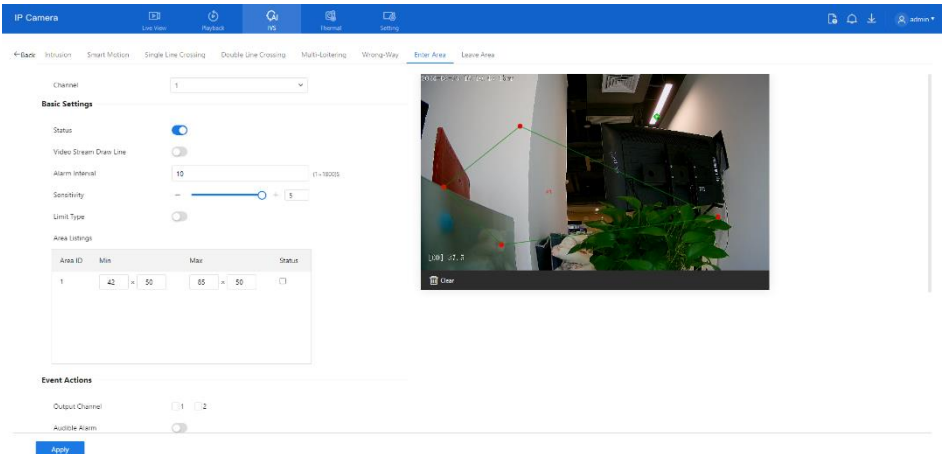

Set all parameters for enter area, please refer to chapter 5.2.1

## 5.2.8 Leave Area

The leave area refers to that an alarm is generated when a target leaves the deployment area at the valid time.

Select **IVS > Intelligent Analysis > Leave Area** to access the **Leave Area** setting interface, as shown in Figure 5-10.

Figure 5-10 Leave Area

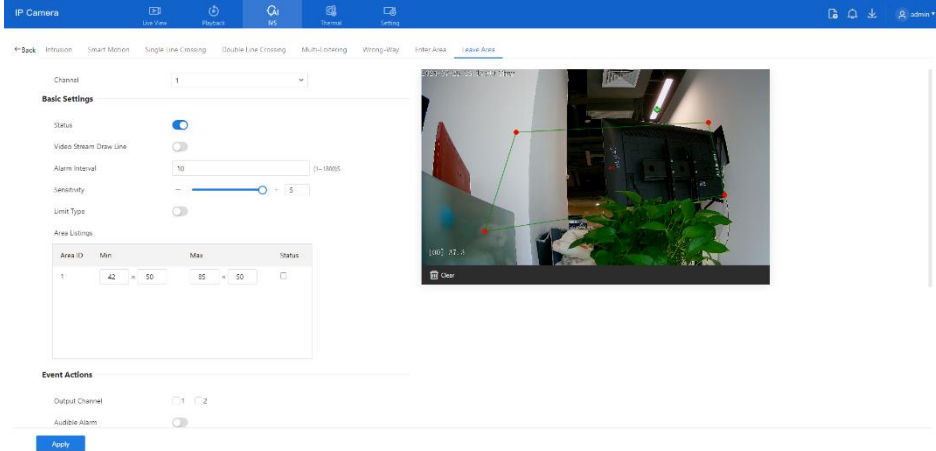

Set all parameters for leave area, please refer to chapter 5.2.1

## 5.3 Environmental Safety Analysis

At the advanced environmental Safety Analysis interface, users can set the parameters of smoking detection, smoke and flame detection, and fire spot detection. Enable the linkage actions, the alarm information can be sent to user by the linkage.

### 5.3.1 Smoking Detection

#### Description

The smoking detection function refers to that an alarm is generated when someone is smoking or generating spark at the deployment area.

This function is only applicable for thermal channel.

Select **IVS > Environmental Analysis > Smoking Detection** to access the **Smoking Detection** interface, as shown in Figure 5-11.

Figure 5-11 Smoking detection interface

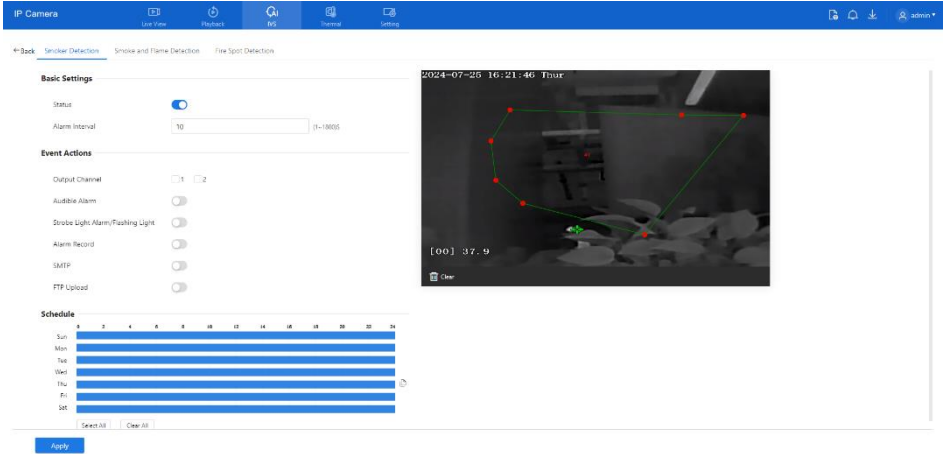

Set all parameters for smoking detection, please refer to chapter 5.2.1

----End

### 5.3.2 Smoke and Flame Detection

The smoke flame detection function refers to that an alarm is generated when something is smoking or generating flame at the deployment area.

This function is only applicable for optical channel.

Select **IVS > Advanced Intelligent Analysis > Smoke and Flame Detection** to access the Smoke and Flame Detection interface, as shown in Figure 5-12.

Figure 5-12 Smoke and flame detection interface

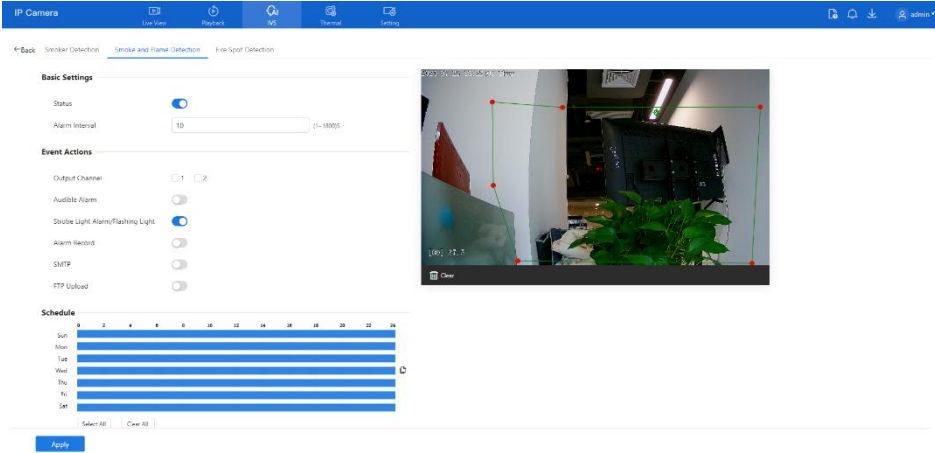

Set all parameters for smoke and flame detection, please refer to chapter 5.2.1

----End

### 5.3.3 Fire Spot Detection

#### Description

The fire spot detection function refers to that an alarm is generated when something is on fire at the deployment area.

This function is only applicable for thermal channel.

#### Procedure

Step 1 Select **IVS > Advanced Intelligent Analysis > Fire Spot Detection** to access the **Fire Spot Detection** interface, as shown in Figure 5-13

Figure 5-13 Fire spot detection interface

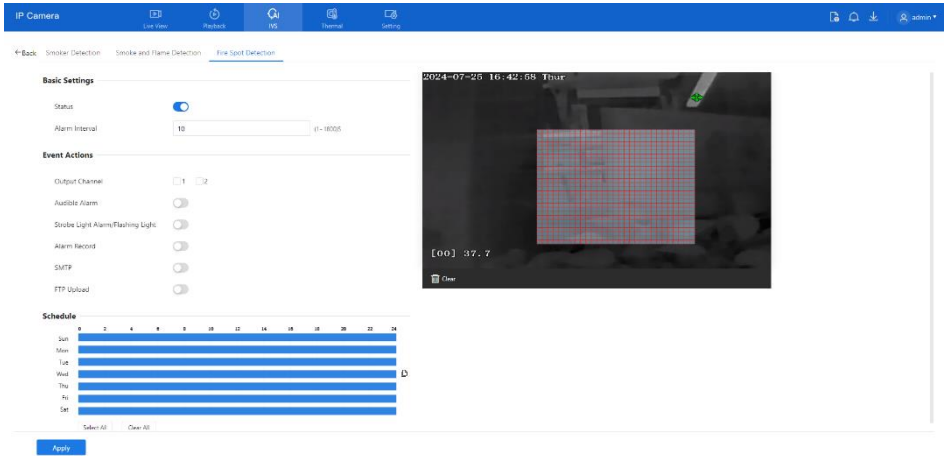

Step 2 Set all parameters for Fire Spot Detection, please refer to chapter 5.2.1

Step 3 Set a deployment area.

Use mouse to draw rectangular area, you can set several area to deploy, as shown in Figure 5-14.

Figure 5-14 Set deployment area

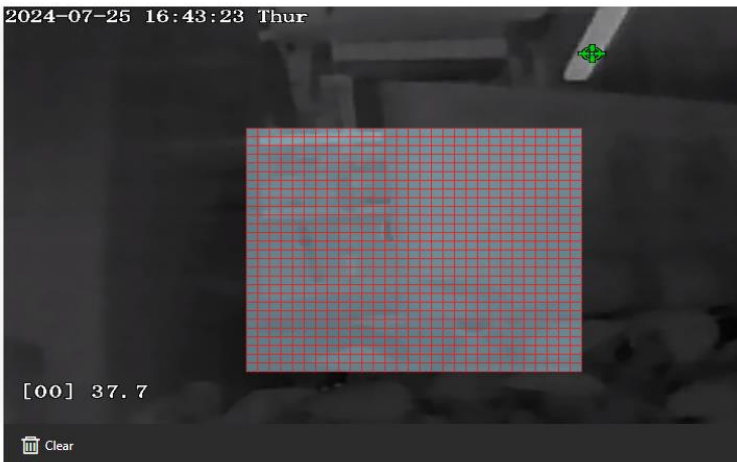

Step 4 Set deployment time, please refer to chapter 4.3 Step 4.

Step 5 Click **Apply** to save the settings.

---End

## 5.4 People Counting

Users can draw line to count the number of people in the special area.

### 5.4.1 Set

#### Procedure

Step 1 Select **IVS > People Counting > Set** to access the **People Counting** setting interface, as shown in Figure 5-15.

Figure 5-15 People counting

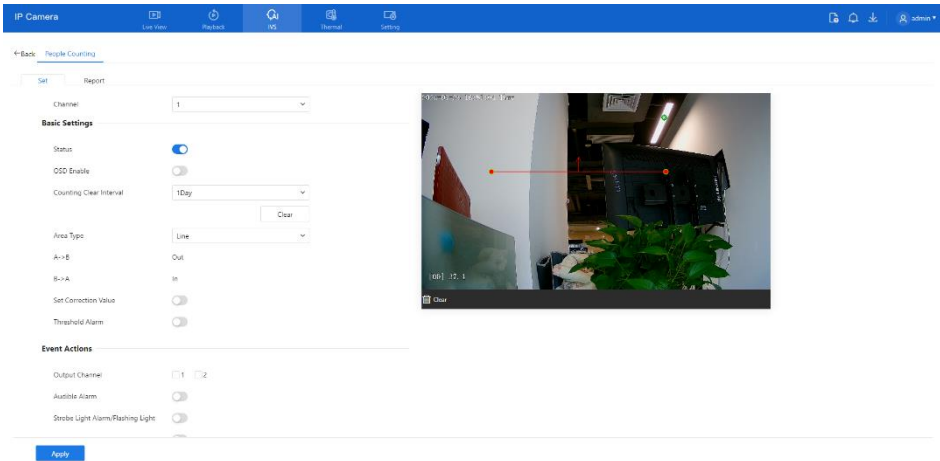

Step 2 Set all parameters for People Counting. Table 5-3 describes the specific parameters.

Table 5-3 Parameters of people counting

Parameter	Description	Setting
Channel	Channel 1: optical. Channel 2: thermal.	[How to set] Choose one channel to set.
Enable	Enable the button to enable the alarm.	[How to set] Click Enable to enable. [Default value] <b>OFF</b>

Parameter	Description	Setting
OSD Enable	Enable the OSD, the count data will show on live video screen.	[How to set] Click Enable to enable. [Default value] <b>OFF</b>
Counting Clear Interval	The camera will clear counting data at the setting interval. Click the “Clear Counting”, clearing the data immediately.	[How to set] Choose from drop-down list. [Default value] <b>1 Day</b>
Area Type	Draw a line on live video screen. The label of A and B indicate out and in.	[How to set] Choose from drop-down list. [Default value] <b>Line</b>
Set Correction Value	Enable, set the count correction value, it can be positive or negative. For example, if there are 30 people enter the area before counting, input 30 to correct. If 30 people go out the area, input -30.	[How to set] Enable /Input a value in the area box. [Default value] <b>0</b>
Threshold Alarm	Enable, when the counting number reaches the threshold value, an alarm is triggered.	[How to set] Click Enable to enable. [Default value] <b>OFF</b>
Threshold	The threshold of enable alarm.	[How to set] Enable /Input a value in the area box. [Default value] <b>1000</b>
Output Channel	If you check to set the Output Channel and the device is connected to an external alarm indicator, the alarm indicator signals when an alarm is triggered.	[How to set] Click to select an ID.
Audible alarm	Enable, when an alarm occurs, it will play audio to alarm. Choose the audible alarm file (set at the “ <b>Configuration &gt; Alarm &gt; Audible Alarm Output</b> ”).	[How to set] Click to enable Audible alarm [Default value] <b>OFF</b>

Parameter	Description	Setting
Flashlight alarm	Enable, when it is triggered alarm, it flashes the light. But when users set the display mode to Mode 5 at “ <b>Thermal &gt; Led Control Param</b> “interface, the light will be always on for 15s, not flash when it is alarm.	[How to set] Click to enable Flashlight Alarm. [Default value] <b>OFF</b>
SMTP	Enable the button to enable SMTP server. The parameters of SMTP can be set at <b>Setting &gt; Network &gt; Advanced Settings &gt; SMTP</b> interface.	[How to set] Click to enable SMTP. [Default value] <b>OFF</b>
FTP Upload	Enable the button to enable File Transfer Protocol. The parameters of FTP can be set at <b>Setting &gt; Network &gt; Advanced Settings &gt; FTP</b> interface.	[How to set] Click to enable FTP Upload. [Default value] <b>OFF</b>

Step 3 Set a deployment area.

Move the cursor to the drawing interface and click to generate a point, move the cursor to draw a line, and then click to generate another point. This is how a line is generated. In this way, continue to draw lines to form any shape, and right-click to finish line drawing.

Step 4 Set deployment time.

Step 5 Click **Apply** to save the settings

----**End**

## 5.4.2 Report

At people counting report interface, you can view the data of people counting through setting query condition (choose the detail time at date’s pop-up window). There are three modes to show the data, such as line chart, histogram, and list, as shown in Figure 5-16.

Figure 5-16 Report of people counting

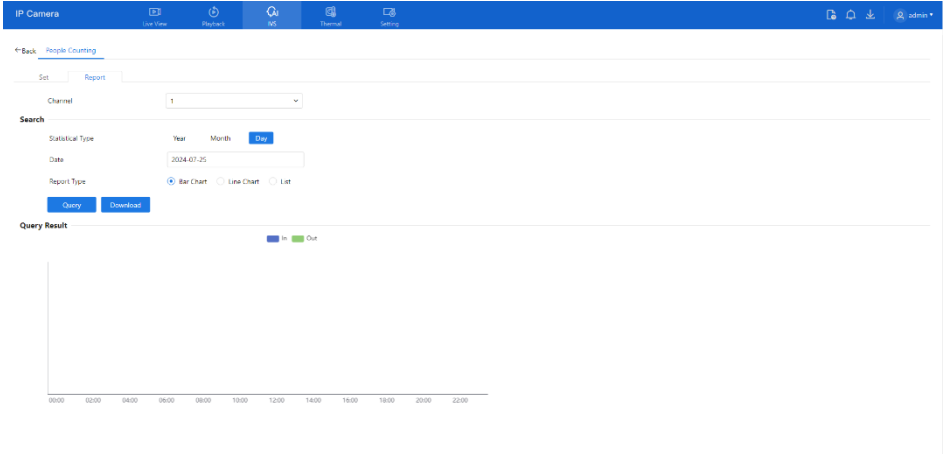

Click “Download” to download the query result.

Choose the mode of showing result, such as line chart, histogram and list.

Click “Query” to query the data of people counting.

The data result can be saved to local folder.

----End

# A Troubleshooting

Common Trouble	Possible Cause	Solution
Unable to access the web	Network is not connected.	Connect the network cable of the camera to the PC to check whether the network cable is in good contact. Run the ping command to check the network connection and whether the device works normally.
	IP address is occupied.	Directly connect the camera to the PC, and reset the IP address of the camera.
	The IP addresses of the PC and the device are in different networks.	Check the IP address, subnet mask and gateway setting of the camera.
The measured temperature is not accurate.	The device is just powered on, and the temperature of the cavity is unstable.	The temperature of the cavity is stable within 15 to 30 minutes after the device is powered on.
	The target configuration is incorrect.	Check whether the emission rate and distance of the target are configured correctly.
An error occurs in accessing the web of the device after the upgrade.	The data in the cache of browser is not updated in time.	Delete the cache of browser. The steps are as follows (taking Edge as an example): Open the Edge. Press Ctrl + Shift + Delete on keyboard. The <b>Delete Browsing History</b> dialog box appears. Select all check boxes. Click <b>Clear</b> to delete. Relogin the web page of the camera.
Upgrade failed.	No network cable is connected. The network setting is incorrect.	Ensure the upgrade network is connected. Check whether the network setting is correct.
	The upgrade package is incorrect.	Perform the correct upgrade package again.

Common Trouble	Possible Cause	Solution
The temperature is too high.	1. Make sure ' <b>thermal mapping</b> ' and ' <b>thermal calibration is configured correctly</b> ' by checking highest temperature object at two channels. 2. Check if the temperature data is inconsistent with the actual temperature, the temperature may be too high.	

## B Common Emission Rate

### Emission Rate

The emission rate is the capability of an object to emit or absorb energy. An ideal transmitter provides an emission rate of emitting 100% of intake energy. An object with an emission rate of 0.8 can absorb 80% of intake energy, and reflect the remaining 20%. The emission rate is the ratio of the energy emitted by an object at a specific temperature to that emitted by an ideal radiator at the same temperature. The range of emission rate value is 0.0 to 1.0 generally.

Materials	Temperature (°C/°F)	Emissivity
Gold (High-purity)	227/440	0.02
Aluminum foil	27/81	0.04
Aluminum sheet	27/81	0.18
Aluminum used for families (flat)	23/73	0.01
Aluminum plate ( 98.3% purity)	227/440	0.04
	577/1070	0.06
Aluminum plate (rough)	26/78	0.06
Aluminum (oxidized @ 599°C)	199/390	0.11
	599/1110	0.19
Polished aluminum	38/100	0.22
Tin (light tinned Iron sheet)	25/77	0.04
Nickel wire	187/368	0.1
Lead (99.9% purity, No oxidized)	127/260	0.06

Copper	199/390	0.18
Cobalt	599/1110	0.19
Steel	199/390	0.52
	599/1110	0.57
Tinned iron sheet (Light)	28/82	0.23
Brass(High-polish)	247/476	0.03
Brass (Tough rolled, polished metal wire)	21/70	0.04
Tinned Iron (Light)	-	0.13
Iron plate (Rust eaten)	20/68	0.69
Rolled steel sheet	21/71	0.66
Ferric oxide	100/212	0.74
Wrought-iron	21/70	0.94
Fused iron	1299-1399/2370-2550	0.29
Copper (Polished)	21-117/70-242	0.02
Copper(Polished, not reflected)	22/72	0.07
Copper (Heavy oxide Board )	25/77	0.78
Enamel (Fuse on iron)	19/66	0.9
Formica Plate	27/81	0.94
Frozen soil	-	0.93
Brick (Red, rough)	21/70	0.93
Brick (Unglazed, rough)	1000/1832	0.8

Carbon (T - carbon 0.9% ash)	127/260	0.81
Concrete	-	0.94
Glass (Glossy)	22/72	0.94
Granite (Surfaced)	21/70	0.85
Ice	0/32	0.97
Marble (I Polished, grey)	22/72	0.93
Asbestos board	23/74	0.96
Asbestos paper	38/100	0.93
	371/700	0.95
Asphalt ( Paving the road)	4/39	0.97
Paper ( Black tar)	-	0.93
Paper (White)	-	0.95
Plastic (White)	-	0.91

170-16-20-0056-03

V1.2